

TEAC®

APPENDIX

SERVICE DATA

EU - 51ST

EU - 66ST

Colour Television with Remote Control

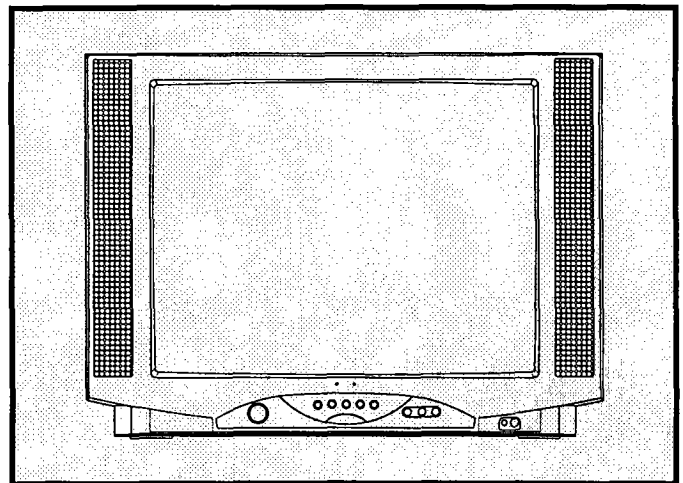

SERVICE MANUAL



CAUTION

RISK OF ELECTRIC SHOCK
DO NOT OPEN



CAUTION: TO REDUCE THE RISK OF ELECTRIC SHOCK, DO NOT REMOVE COVER (OR BACK). NO USER-SERVICEABLE PARTS INSIDE. REFER SERVICING TO QUALIFIED SERVICE PERSONNEL.



The lightning flash with arrowhead symbol, within an equilateral triangle, is intended to alert the user to the presence of uninsulated "dangerous voltage" within the product's enclosure that may be of sufficient magnitude to constitute a risk of electric shock of persons.



The exclamation point within an equilateral triangle is intended to alert the user to the presence of important operating and maintenance (servicing) instructions in the literature accompanying the appliance.

WARNING: TO PREVENT FIRE OR SHOCK HAZARD, DO NOT EXPOSE THIS APPLIANCE TO RAIN OR MOISTURE.

APPLICATION NOTE-1

HOW TO ADD "CLOSED CAPTION" FEATURE TO 11AK19 CHASSIS ?

Necessary boards:

- 11CCM19 Vestel Code: 20014926
- 11CC19-1 Vestel Code: 20002051

- Plug the 11CC19-1 board into the PL401 socket so that the copper side will point out the tuner.
- Remove the diodes D506, D507, D508.
- Insert 11CCM19 board instead of the cathode positions of these diodes via PL301.
- Connect the wires from PL302 (on the 11CCM19 board) to the anode positions of these diodes.
- Connect a 5 cm. length cable between the PL303 (on the 11CCM19 board) and the metal shield which covers the "video stage".
- Connect a cable between the pin 3 of PL401 and pin 16 of SCART 1 (SC050) under the main PCB.
- Connect the 5 wires from PL300 (on the 11CCM19 board) to the socket on the 11CC19-1 board.
- Change the necessary components as follows:

R448	RES CF 1/4W 1K
R465	RES SMD 1/10W 1K
R447	RES SMD 1/10W 560R
L406	FIXED COIL 10 μ H
C428	CAP EL 10 μ F / 50V
Q415	TR BC548B
S415	JUMPER SMD
S416	JUMPER WIRE
J141	DISCONNECTED

APPLICATION NOTE-2

AFC & AGC SETTING PROCEDURE FOR 11AK19 CHASSIS:

1-) FOR AFC SETTING :

- Apply a 38.9 MHz. / 80 dB μ V standart PAL B/G IF signal to the terminals of L201 fixed coil via a pattern generator.
- Enter service mode and select "ADJUST 04". Change it until you obtain the "IN/DOWN" symbol on the screen.
- Switch off the TV to store this adjustment in the memory.

2-) FOR AGC SETTING :

- Apply a standart e.g: 224.25 MHz. / 60 dB μ V standart PAL B/G signal to the antenna input via a pattern generator.
- Enter the service mode (press "blue bton" on the handset and then type 4,7,2,5). Select " ADJUST" menu and enter it. Select the AGC adjustment item (ADJUST 03).
- Measure the voltage on pin 1 of the tuner via a voltmeter.
- Adjust AGC level by means of the arrow keys on the remote control unit until you obtain the max. voltage value.
- When you get the max. voltage on that pin, adjust this voltage to 1 Volt lower than the max. value. (The max. voltage is approx. 3.7 V, so you have to adjust AGC voltage to 3.7-1=2.7V).
- Increase the signal level up to 90 dB μ V and test the picture.
- Switch off the TV to store this adjustment in the memory.

APPROPRIATE SETTING VALUES:

- **AGC VOLTAGE (at Pin 1 of tuner) : 2.7V**

11AK19 SERVICE ADJUSTMENT VALUES

		90°			110°		
		CONSTANT VALUE	ADJUST RANGE (!)	NOT EFFECTE	CONSTANT VALUE	ADJUST RANGE (!)	NOT EFFECTE
ADJUST 00	White Point RED	35					
ADJUST 01	White Point GREEN	35					
ADJUST 02	White Point BLUE	35					
ADJUST 03	AGC		20-32				
ADJUST 04	IF-PLL Negative	80			80		
ADJUST 05	IF-PLL Positive	80			80		
ADJUST 06	Y-Delay PAL	0			0		
ADJUST 07	Y-Delay SECAM	6			6		
ADJUST 08	Y-Delay NTSC	8			8		
ADJUST 09	Y-Delay OTHER	4			4		
ADJUST 10	4:3 Vertical Zoom	13			13		
ADJUST 11	4:3 Vertical Scroll	13			13		
ADJUST 12	4:3 Horizontal Shift		17-43			20-32	
ADJUST 13	4:3 Vertical Slope		28-45			30-41	
ADJUST 14	4:3 Vertical Amplitude		40-58			38-49	
ADJUST 15	4:3 S-Correction		14-28				
ADJUST 16	4:3 Vertical Shift		24-35			30-42	
ADJUST 17	4.3 EW Width	52		!!		48-53	
ADJUST 18	4.3 EW Parabola Widht	34		!!		45-52	
ADJUST 19	4.3 EW Corner Parabola	31		!!		18-28	
ADJUST 20	4.3 EW Trapezium	6		!!		20-32	
ADJUST 21	16:9 Vertical Zoom	13			13		
ADJUST 22	16:9 Vertical Scroll	13			13		
ADJUST 23	16:9 Horizontal Shift		20-30			24-36	
ADJUST 24	16:9 Vertical Slope		30-45			30-45	
ADJUST 25	16:9 Vertical Amplitude		0-5			0-5	
ADJUST 26	16:9 S-Correction		0-10			0-10	
ADJUST 27	16:9 Vertical Shift		24-33			25-38	
ADJUST 28	16:9 EW Width			!!		45-55	
ADJUST 29	16:9 EW Parabola Widht			!!		24-34	
ADJUST 30	16:9 EW Corner Parabola			!!		35-48	
ADJUST 31	16:9 EW Trapezium			!!		23-33	
ADJUST 32	Cinema Vertical Zoom			!!			X
ADJUST 33	Cinema Vertical Scroll			!!			X
ADJUST 34	Cinema Horizontal Shift			!!			X
ADJUST 35	Cinema Vertical Slope			!!			X
ADJUST 36	Cinema Vertical Amplitude			!!			X
ADJUST 37	Cinema S-Correction			!!			X
ADJUST 38	Cinema Vertical Shift			!!			X
ADJUST 39	Cinema EW Width			!!			X
ADJUST 40	Cinema EW Parabola Widht			!!			X
ADJUST 41	Cinema EW Corner Parabola			!!			X
ADJUST 42	Cinema EW Trapezium			!!			X
ADJUST 43	OSD Position	149±2			149±2		

X : VALUES ARE ONLY FOR 16:9
 ! : SUGGESTED VALUE RANGE
 !! : NOT EFFECTED

OPTIONAL COMPONENTS LIST

10002704 EU-51ST

VESTEL CODE	DESCRIPTION	POSITION NUMBER			
SYSTEM PAL BG	30000092	CAP MKT 220NF 63V J	C415		
	30000295	CAP CER 100NF 50V Z F	CX41		
	30000628	RES CF 1/4W 2.7K J	RX10	RX11	
	30000712	RES CF 1/4W 470R J	J126	J127	
	30001575	IC TDA8842/N2	IC401		
	30001693	FILTER SAW G3962	Z401		
	30001748	XTAL 4.433619 MHZ	X401		
	30001808	CONN.MALE 12P MOLEX	PL403		
	30001810	CONN.MALE 14P MOLEX	PL404		
	30002388	CABLE 0.6MM BLUE	CAB011	CAB021	
	20000849	FUSE ASSY.TK79-A (3.15A)	F801		
	30001732	FUSE 3.15A 250V 5*20			
	35000138	FUSE HOLDER TK79A (BLACK)	F801		
	30000422	CAP EL 330UF 400V M	C804		
	30001107	RES MO 3W 15K J	R806		
	30001260	RES WW 5W 2.2R J RAD.	R817		
	30001305	DIODE BYM56E	D801	D802	D803 D804
	20015426	M.B.A.19-SMPS 90-270V 90° SDA 54XX RAD			
	20015427	M.B.A.19-SMPS 90-270V 90° SDA 54XX AXI			
	20015428	M.B.A.19-SMPS 90-270V 90° SDA 54XX SEQ			
	20015429	M.B.A.19-SMPS 90-270V 90° SDA 54XX JUM			
	30000471	RES CF 1/4W 10K J	R808		
	30000540	RES CF 1/2W 1.5M J (400V)	R816		
	30000660	RES CF 1/4W 3.3K J	R871		

TELETEXT	VESTEL CODE	DESCRIPTION	POSITION NUMBER			
	30002229	CONN.ASSY.15CM 3P MON.LED				
	30006662	XTAL 6MHZ	X501			
	30006718	IC SDA545X OTP	IC501			
	20014995	MAIN B.ASSY.19-TXT (TEAC) RAD				
	20014996	MAIN B.ASSY.19-TXT (TEAC) AXI				
	20014997	MAIN B.ASSY.19-TXT (TEAC) SEQ				
	30000466	RES CF 1/4W 1K J	R448			
	30000500	RES CF 1/4W 12K J	R711			
	30000633	RES CF 1/4W 27K J	R547			
	30000718	RES CF 1/4W 4.7K J	R710			
	30001284	DIODE 1N4148	D510	D506	D507 D508	
	30000100	CAP MKT 330NF 63V J	C521			
	30000345	CAP EL 10UF 50V M	C428			
	30001454	TR BC548B	Q415	Q702		
	30000236	CAP SMD 33PF 50V J	C524	C525		
	30000288	CAP SMD 10NF 50V K	C506			
	30000469	RES SMD 1/10W 1K J 0805	R447			
	30000484	RES SMD 1/10W 1M J (0805)	R584			
	30000631	RES SMD 1/10W 2.7K J 0805	R540			
	30000696	RES SMD 1/10W 39K J (0805)	R548			

POWER SUPPLY	VESTEL CODE	DESCRIPTION	POSITION NUMBER			
	30000161	CAP MKP 47NF 630V J	C811			
	30001129	RES MO 22K 3W J	R822			
	20000849	FUSE ASSY.TK79-A (3.15A)	F801			
	30001732	FUSE 3.15A 250V 5*20				
	35000138	FUSE HOLDER TK79A (BLACK)	F801			
	30000422	CAP EL 330UF 400V M	C804			
	30001107	RES MO 3W 15K J	R806			
	30001260	RES WW 5W 2.2R J RAD.	R817			
	30001305	DIODE BYM56E	D801	D802	D803 D804	
	30000471	RES CF 1/4W 10K J	R808			
	30000540	RES CF 1/2W 1.5M J (400V)	R816			
	30000660	RES CF 1/4W 3.3K J	R871			

PICTURE TUBE	THOMSON A51EBV13X25	VESTEL CODE	DESCRIPTION	POSITION NUMBER		
		30000123	CAP PP 33NF 630V K	C610		
		30000143	CAP MKP 2.2NF 2KV %3.5	C611		
		30000172	CAP MKP 680NF 250V J (P15)	C617		
		30000180	CAP MKP 9.1NF 2000V %3.5	C626		
		30000712	RES CF 1/4W 470R J	R717		
		30000815	RES CF 1/4W 8.2K J	R613	R615	
		30000860	RES MF 1/4W 1R F	R703		
		30001215	RES FUSE 1W 1R J	R611		
		30001855	SOCKET CRT NARROWNECK W/GND	PL900		
		30002026	FIXED COIL 1MH AK19 25/28	L602		

10002697 EU-66ST

	VESTEL CODE	DESCRIPTION	POSITION NUMBER				
SYSTEM PAL BG	30000092	CAP MKT 220NF 63V J	C415				
	30000295	CAP CER 100NF 50V Z F	CX41				
	30000628	RES CF 1/4W 2.7K J	RX10	RX11			
	30000712	RES CF 1/4W 470R J	J126	J127			
	30001579	IC TDA8844/N2	IC401				
	30001693	FILTER SAW G3962	Z401				
	30001748	XTAL 4.433619 MHZ	X401				
	30001808	CONN.MALE 12P MOLEX	PL403				
	30001810	CONN.MALE 14P MOLEX	PL404				
	30002388	CABLE 0.6MM BLUE	CAB011	CAB021			
	30001745	XTAL 3.579545	X404				
	30002583	JUMPER WIRE 0.6MM	C451	C452	L403	S503	S504
			S505	S510	J200		
	30000109	CAP MKT 470NF 63V J	C113				
	30000284	CAP SMD 1NF 50V K R (0805)	C490				
	30000322	CAP SMD 3.3NF 50V K (0805)	C439				
	30000499	RES SMD 1/10W 1.2K J (0805)	R421				
	30000503	RES SMD 1/10W 12K J (0805)	R561	R574			
	30000558	RES SMD 1/10W 180R J	R422				
	30000593	RES SMD 1/10W 2.2K J (0805)	R420				
	30000717	RES SMD 1/10W 470R J (0805)	R465				
	30001734	JUMPER SMD (0805)	S065				
	30001734	JUMPER SMD (0805)	R478				

	VESTEL CODE	DESCRIPTION	POSITION NUMBER				
TELETEXT	30002229	CONN.ASSY.15CM 3P MON.LED					
	30006662	XTAL 6MHZ	X501				
	30006718	IC SDA545X OTP	IC501				
	30000466	RES CF 1/4W 1K J	R448				
	30000500	RES CF 1/4W 12K J	R711				
	30000633	RES CF 1/4W 27K J	R547				
	30000718	RES CF 1/4W 4.7K J	R710				
	30001284	DIODE 1N4148	D510	D506	D507	D508	
	30000100	CAP MKT 330NF 63V J	C521				
	30000345	CAP EL 10UF 50V M	C428				
	30001454	TR BC548B	Q415	Q702			
	30000236	CAP SMD 33PF 50V J	C524	C525			
	30000288	CAP SMD 10NF 50V K	C506				
	30000469	RES SMD 1/10W 1K J 0805	R447				
	30000484	RES SMD 1/10W 1M J (0805)	R584				
	30000631	RES SMD 1/10W 2.7K J 0805	R540				
	30000696	RES SMD 1/10W 39K J (0805)	R548				

	VESTEL CODE	DESCRIPTION	POSITION NUMBER				
POWER SUPPLY	30000161	CAP MKP 47NF 630V J	C811				
	30001129	RES MO 22K 3W J	R822				
	20000965	HEAT.ASSY.19-SMPS 110w 90-270V					
	30001388	TR MTW8N60E	Q802				
	35000015	SPRING TR.HOLDER (BIG)					
	35000117	HEATSINK 19-PRIMER 110'					
	40000145	INSULATOR SILICON PAD(20*30MM)					
	30001159	RES MO 1W 0.33R J	R819	R870			
	30002081	TRF SMPS AK19 110° (90-270V)	TR802				
	30002104	LINE FILTER 2X22MH (AK16)	TR801				
	20000849	FUSE ASSY.TK79-A (3.15A)	F801				
	30001732	FUSE 3.15A 250V 5*20					
	35000138	FUSE HOLDER TK79A (BLACK)	F801				
	30000422	CAP EL 330UF 400V M	C804				
	30001107	RES MO 3W 15K J	R806				
	30001260	RES WW 5W 2.2R J RAD.	R817				
	30001305	DIODE BYM56E	D801	D802	D803	D804	
	30000471	RES CF 1/4W 10K J	R808				
	30000540	RES CF 1/2W 1.5M J (400V)	R816				
	30000660	RES CF 1/4W 3.3K J	R871				

	VESTEL CODE	DESCRIPTION	POSITION NUMBER				
PICTURE TUBE	VIDEOCOLOR A66EHJ43X99						
	30000123	CAP PP 33NF 630V K	C610				
	30000143	CAP MKP 2.2NF 2KV %3.5	C611				
	30000172	CAP MKP 680NF 250V J (P15)	C617				
	30000180	CAP MKP 9.1NF 2000V %3.5	C626				
	30000712	RES CF 1/4W 470R J	R717				
	30000815	RES CF 1/4W 8.2K J	R613	R615			
	30000860	RES MF 1/4W 1R F	R703				
	30001215	RES FUSE 1W 1R J	R611				
	30001855	SOCKET CRT NARROWNECK W/GND	PL900				
	30002026	FIXED COIL 1MH AK19 25/28	L602				

HOTEL MODE FEATURE

This is the text that explains how the password menu will work for hotel-tv mode in TEAC project. Size key, which is placed in left-bottom and not valid in only-TV-mode, will be used (if hotel mode is supported--option19 bit0 is set)(NOTE-1) to display the password line on OSD as the following:



If the password is okay then extra *three* lines will appear as "new password", "hotel mode" and "store." The user will be able to change the password via the first new line, and can store it by accessing the "store" line, as the confirmation of the new password. To change the hotel mode, the user do not have to store it ,i.e, as soon as s/he close the menu, the mode will be the same as s/he did.

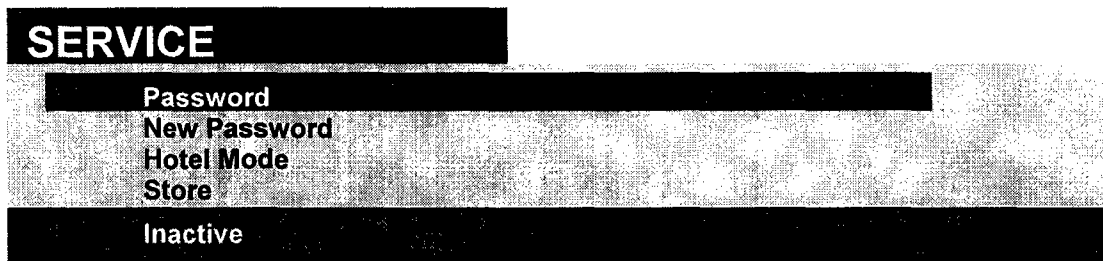

If the user try to get a password different from four digits, for example 3 digit-password, s/he can not store it, store operation is valid only for four-digit passwords. However you can insist on saving some eeprom space of yourself by choosing a password like "0007"!

In the case of forgetting the password, the user(TEAC) can not toggle the hotel mode, because s/he can not access the options menu by entering the necessary password in the installation menu, and (IB) also can not toggle via the password menu in the hotel mode, because s/he forgot the password. For this situation, we realized that, but this will be known only by TEAC not by IB, if the "crash number-" ,which is 1325, is entered as password then *password will take the value of the "crash number"*, and new menu will appear ,so, you can access the features.

For the improper 'new password', which is not four digits, the OSD will show the entered digits, in fact, entered stars, and the store operation won't be allowed. To clear the previous digits, the user must complete the current entries to four digits and now s/he can reenter the new password as s/he want.

Appending..

Option 19-bit0=== 1→hotel mode supported
(size key available-then hotel password menu)

0→hotel mode not supported
(size key is nonfunctional in TV mode)

hotel mode=== OFF→ menu_key (main menu)
red key* (sound m.)
green key* (picture)
yellow key* (feature)
blue key* (install)

(These keys are already valid in text mode independent from hotel mode status.)

ON→ no access to above menus
Only to hotel features

**SERVICE
MANUAL**

TELEVISION COLOUR

CHASSIS 11AK19

FOR ALL MODELS

CONTENTS

Contents	1
Safety Precautions	2
TV Set switched off	2
Measurements	2
PERI-TV SOCKET	2
SCART 1	2
SCART 2	2
INTRODUCTION	2
SMALL SIGNAL PART WITH TDA884X	2-3
TUNER	4
VIDEO SWITCH TEA6415C	4
AM DEMODULATOR TDA9830	4-5
DIGITAL TV SOUND PROCESSOR TDA9875	5
SOUND OUTPUT STAGE TDA2614/TDA2615/TDA2616Q	5
VERTICAL OUTPUT STAGE WITH TDA8351/TDA8356	6
VIDEO OUTPUT AMPLIFIER TDA6107Q	6
SINGLE/MULTISTANDARD VIF/SIF-PLL and FM-PLL/AM DEMODULATOR TDA9818	6
COMB FILTER SAA4961	6
POWER SUPPLY (SMPS)	6
MICROCONTROLLER SDA525X	6
SERIAL ACCESS CMOS 8K (1024*8) EEPROM ST24C08	6
CLASS AB STEREO HEADPHONE DRIVER TDA1308	7
SAW FILTERS	7
IC DESCRIPTIONS AND INTERNAL BLOCK DIAGRAM	7
TDA8840/TDA8842/TDA8844	7-8
UV1315/UV1316/UV1336	9-10
TEA6415C	10
TDA9830	10
TDA2614/TDA2615/TDA2616Q	11-12
TDA8351/TDA8356	12
TDA6107Q	13
SAA4961	13-14
MC44604	14-15
SDA525X	16-17
TDA9875	17-18
TDA9818	18
ST24C08	18
TDA1308	18
G1965M	18
TDA9855	19
AK19 CHASSIS MANUAL ADJUSTMENT PROCEDURE	20
For Adjust Settings	20
WHITE BALANCE ADJUSTMENT	20
AGC ADJUSTMENT	20
IF-PLL NEGATIVE ADJUSTMENT	20
IF-PLL POSITIVE ADJUSTMENT	20
LUMINANCE DELAY ADJUSTMENT	20
VERTICAL ZOOM ADJUSTMENT	20
VERTICAL SCROLL ADJUSTMENT	20
4 : 3 HORIZONTAL SHIFT ADJUSTMENT	20
4 : 3 VERTICAL SLOPE ADJUSTMENT	20
4 : 3 VERTICAL AMPLITUDE ADJUSTMENT	21
4 : 3 S-CORRECTION ADJUSTMENT	21
4 : 3 VERTICAL SHIFT ADJUSTMENT	21
4 : 3 EW WIDTH ADJUSTMENT	21
4 : 3 EW PARABOLA WIDTH ADJUSTMENT	21
4 : 3 EW CORNER PARABOLA ADJUSTMENT	21
4 : 3 EW TRAPEZIUM ADJUSTMENT	21
16 : 9 HORIZONTAL SHIFT ADJUSTMENT	21
16 : 9 VERTICAL SLOPE ADJUSTMENT	21
16 : 9 VERTICAL AMPLITUDE ADJUSTMENT	21
16 : 9 S-CORRECTION ADJUSTMENT	21
16 : 9 VERTICAL SHIFT ADJUSTMENT	21
16 : 9 EW WIDTH ADJUSTMENT	21
16 : 9 EW PARABOLA WIDTH ADJUSTMENT	21
16 : 9 EW CORNER PARABOLA ADJUSTMENT	22
16 : 9 EW TRAPEZIUM ADJUSTMENT	22
For Option Settings	22
OPTION 00	22
OPTION 01	23
OPTION 02	23
OPTION 03	23-24
OPTION 04	24
OPTION 05	24
OPTION 06	24
OPTION 07	24-25
OPTION 08	25
OPTION 09	25
OPTION 10	25
GENERAL BLOCK DIAGRAM OF CHASSIS AK19	26
ELECTRONIC COMPONENT PART LIST	27-28

DO NOT CHANGE ANY MODULE UNLESS THE SET IS SWITCH OFF

The mains supply side of the switch mode power supply transformer is live.

Use an isolating transformer.

The receivers fulfill completely the safety requirements.

Safety precautions:

Servicing of this TV should only be carried out by a qualified person.

- Components marked with the warning symbol on the circuit diagram are critical for safety and must only be replaced with an identical component.

- Power resistor and fusible resistors must be mounted in an identical manner to the original component.

- When servicing this TV, check that the EHT does not exceed 26kV.

TV Set switched off:

Make short-circuit between HV-CRT clip and CRT ground layer.

Short C804 (150mF) before changing IC802 or other components in primary side of SMPS.

Measurements:

Voltage readings and oscilloscope traces are measured under following conditions.

Antenna signal 60dB from colourbar generator. (100% white, 75% colour saturation)

Brightness, contrast, colour set for a normal picture.

Mains supply, 220VAC, 50Hz.

PERI-TV SOCKET

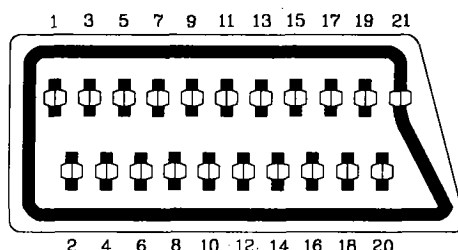

SCART 1 (SC050)

1	Audio right output	0.5Vrms / 1K
2	Audio right input	0.5Vrms / 10K
3	Audio left output	0.5Vrms / 1K
4	Ground AF	
5	Ground Blue	
6	Audio left input	0.5Vrms / 10K
7	Blue input	0.7Vpp / 75ohm
8	AV switching input	0-12VDC / 10K
9	Ground Green	
10	-	
11	Green input	0.7Vpp / 75ohm
12	-	
13	Ground Red	
14	Ground Blanking	
15	Red input	0.7Vpp / 75ohm
16	Blanking input	0-0.4VDC, 1-3VDC / 75ohm
17	Ground CVS output	
18	Ground CVS input	
19	CVS output	1Vpp / 75ohm
20	CVS input	1Vpp / 75ohm
21	Ground	

SCART 2 (SC051)

1	Audio right output	0.5Vrms / 1K
2	Audio right input	0.5Vrms / 10K
3	Audio left output	0.5Vrms / 1K
4	Ground AF	
5	Ground Blue	
6	Audio left input	0.5Vrms / 10K
7	Blue input	0.7Vpp / 75ohm
8	AV switching input	0-12VDC / 10K
9	Ground Green	
10	-	
11	-	
12	-	
13	Ground Red	
14	Ground Blanking	
15	-	
16	-	
17	Ground CVS output	
18	Ground CVS input	
19	CVS output	1Vpp / 75ohm
20	CVS input	1Vpp / 75ohm
21	Ground	

1. INTRODUCTION

11AK19 is a 90ø and 110ø chassis capable of driving 20-21", 24", 25", 28-29", 32", 33" tubes at appropriate currents.

The chassis is capable of working in both PAL and SECAM. The sound system is capable of giving 6watts

RMS output into a load of 8ohms.

One 8 page simple TELETEXT, TOPTXT and FASTEXT is provided.

The chassis is equipped with 21-pin scart connectors which can accept via scart the SVHS format from VCRs so equipped.

2. SMALL SIGNAL PART WITH TDA884X

The TDA8840/8842/8844 combine all small signal functions required for a colour TV receiver, except tuning.

2.1. Vision IF amplifier

The IF-amplifier contains 3 AC-coupled control stages with a total gain control range which is higher than 66dB.

The sensitivity of the circuit is comparable with that of modern IF-IC's. The video signal is demodulated by means of a PLL carrier regenerator. This circuit contains a frequency detector and a phase detector. The AFC output is obtained by using the VCO control voltage of the PLL and can be read via the I²C-bus. For fast search tuning systems the window of the AFC can be increased with a factor 3. The setting is realised with the AFW bit.

Depending on the type the AGC-detector operates on top-sync level (single standard versions) or on top sync and top white-level (multi standard versions). The demodulation polarity is switched via the I²C-bus. The AGC detector time-constant capacitor is connected externally. This mainly because of the flexibility of the application. The time-constant of the AGC system during positive

modulation is rather long to avoid visible variations of the signal amplitude. To improve the speed of the AGC system a circuit has been included which detects whether the AGC detector is activated every frame period. When during 3 frame periods no action is detected the speed of the system is increased. For signals without peak white information the system switches automatically to a gated black level AGC. Because a black level clamp pulse is required for this way of operation the circuit will only switch to black level AGC in the internal mode.

The circuits contain a video identification circuit which is independent of the synchronisation circuit. Therefore search tuning is possible when the display section of the receiver is used as a monitor. The ident output is supplied to the tuning system via the I²C-bus. The video ident circuit can be made less sensitive by means of the STM bit. This mode can be used during search tuning to avoid that the tuning system will stop at very weak input signals.

2.2. Video Switches

The circuits have two CVBS inputs (internal and external CVBS) and Y/C input. When the Y/C input is not required the Y input can be used as third CVBS input. The selection of the various sources is made via the I²C-bus. The circuit has one CVBS output.

2.3. Sound Circuit

The sound band pass and trap filters have to be connected externally. The filtered intercarrier signal is fed to a limiter circuit and is demodulated by means of a PLL demodulator. This PLL circuit tunes itself automatically to the incoming carrier signal so that no adjustment is required.

The volume is controlled via the I²C-bus. The deemphasis capacitor has to be connected externally. The non-controlled audio signal can be obtained from this pin. The FM demodulator can be muted via the I²C-bus. This function can be used to switch-off the sound during a channel change so that high output peaks are prevented. The TDA8840/8842 contain an automatic volume levelling (AVL) circuit which automatically stabilises the audio output signal to a certain level which can be set by the viewer by means of the volume control. This function prevents big audio output fluctuations due to variations of the modulation depth of the transmitter. The AVL function can be activated via the I²C-bus.

2.4. Synchronisation circuit

The sync separator is preceded by a controlled amplifier which adjusts the sync pulse amplitude to a fixed level. These pulses are fed to the slicing stage which is operating at 50% of the amplitude. The separated sync pulses are fed to the first phase detector and to the coincidence detector. This coincidence detector is used to detect whether the line oscillator is synchronised and can also be used for transmitter identification. The first PLL has a very high static steepness so that the phase of the picture is independent of the line frequency.

The horizontal output signal is generated by means of an oscillator which is running at twice the line frequency. Its frequency is divided by 2 to lock the first control loop to the incoming signal. The time-constant of the loop can be forced by the I²C-bus (fast or slow). If required the IC can select the time-constant depending on the noise content of the incoming video signal.

To protect the horizontal output transistor, the horizontal drive is immediately switched off when a power-on-reset is detected.

The drive signal is switched-on again when the normal switch-on procedure is followed.

Via the I²C-bus, adjustments can be made of the horizontal and vertical geometry. The vertical sawtooth generator drives the vertical output drive circuit which has a differential output current. For the EW drive a single ended current output is available.

When the horizontal scan is reduced to display 4 : 3 pictures on a 16 : 9 picture tube an accurate video blanking can be switched on to obtain well defined edges on the screen.

Overvoltage conditions can be detected via the EHT tracking pin. When an overvoltage condition is detected the horizontal output drive signal will be switched-off via the slow stop procedure but it is also possible that the drive is not switched-off and that just a protection indication is given in the I²C-bus output byte. The choice is made via the input bit PRD.

2.5. Chroma and Luminance processing

The circuits contain a chroma bandpass and trap circuit. The filters are realised by means of gyrator circuits and they are automatically calibrated by comparing the tuning frequency with the X-tal frequency of the decoder.

The luminance delay line and the delay for the peaking circuit are also realised by means of gyrator circuits.

The centre frequency of the chroma bandpass filter is switchable via the I²C-bus so that the performance can be optimised for "front-end" signals and external CVBS signals.

During SECAM reception the centre frequency of the chroma trap is reduced to get a better suppression of the SECAM carrier frequencies.

2.6. Colour Decoder

The decoder contains an alignment-free X-tal oscillator, a killer circuit and two colour difference demodulators. The 90° phase shift for the reference signal is made internally.

The IC contains an automatic colour limiting (ACL) circuit which prevents that oversaturation occurs when signals with a high chroma-to-burst ratio are received. The ACL circuit is designed such that it only reduces the chroma signal and not the burst signal. This has the advantage that the colour sensitivity is not affected by this function.

The base-band delay line is integrated in the PAL/SECAM IC's.

The demodulated colour difference signals are internally supplied to the delay line. The matrixed signals are externally available.

The colour difference matrix switches automatically between

PAL/SECAM and NTSC, however, it is also possible to fix the matrix in the PAL standard.

Which colour standard the IC can decode depends on the external X-tals. The X-tal to be connected to pin 34 must have a frequency of 3.5 MHz (NTSC-M, PAL-M or PAL-N) and pin 35 can handle X-tals with a frequency of 4.4 and 3.5 MHz. To prevent calibration problems of the horizontal oscillator the external switching between the 2 X-tals should be carried out when the oscillator is forced to pin 35. For a reliable calibration of the horizontal oscillator it is very important that the X-tal indication bits (XA and XB) are not corrupted. For this reason the X-tal bits can be read in the output bytes so that the software can check the I²C-bus transmission.

2.7. RGB output circuit and black-current stabilisation

The colour-difference signals are matrixed with the luminance signal to obtain the RGB-signals. The TDA 884X device has one linear RGB input. This RGB signal can be controlled on contrast and brightness.

The output signal has an amplitude of about 2 volts black-to-white at nominal input signals and nominal settings of the controls.

To increase the flexibility of the IC it is possible to insert OSD and/or teletext signals directly at the RGB outputs.

This insertion mode is controlled via the insertion input (pin 26 in the S-DIP 56- and pin 38 in the QFP-64 level). This blanking action at the RGB outputs has some delay which must be compensated externally.

To obtain an accurate biasing of the picture tube a "Continuous Cathode Calibration" circuit has been developed.

This function is realised by means of a 2-point black level stabilisation circuit.

When the TV receiver is switched-on, the RGB output signals are blanked and the black current loop will try to set the right picture tube bias levels. Via the AST bit a choice can be made between automatic start-up or a start-up via the m-processor.

3. TUNER

Either a PLL or a VST tuner is used as a tuner.

UV1316 (VHF/UHF) is used as a PLL tuner. For only PALM/N, NTSC M applications UV 1336 is used as the PLL tuner. UV 1315 (VHF/UHF) is used as a VST Tuner.

Channel coverage of UV1316:

BAND	OFF-AIR CHANNELS		CABLE CHANNELS	
	CHANNELS RANGE (MHz)	FREQUENCY	CHANNELS	FREQUENCY RANGE (MHz)
Low Band	E2 to C	48.25 to 82.25 (1)	S01 to S08	69.25 to 154.25
Mid Band	E5 to E12	175.25 to 224.25	S09 to S38	161.25 to 439.25
High Band	E21 to E69	471.25 to 855.25 (2)	S39 to S41	447.25 to 463.25

(1). Enough margin is available to tune down to 45.25 MHz.

(2). Enough margin is available to tune up to 863.25 MHz.

Noise	Typical	Max.	Gain	Min.	Typical	Max.
Low band	: 5dB	9dB	All channels	: 38dB	44dB	52dB
Mid band	: 5dB	9dB	Gain Taper (of-air channels)	: -	-	8dB
High band	: 6dB	9dB				

Channel Coverage UV1336:

BAND	CHANNELS	FREQUENCY RANGE (MHz)
Low Band	2 to D	55.25 to 139.25
Mid Band	E to PP	145.25 to 391.25
High Band	QQ to 69	397.25 to 801.25

Noise is typically 6dB for all channels. Gain is minimum 38dB and maximum 50dB for all channels.

Channel Coverage of UV1315:

BAND	OFF-AIR CHANNELS		CABLE CHANNELS	
	CHANNELS	FREQUENCY RANGE (MHz)	CHANNELS	FREQUENCY RANGE (MHz)
Low Band	E2 to C	48.25 to 82.25 (1)	S01 to S10	69.25 to 168.25
Mid Band	E5 to E12	175.25 to 224.25	S11 to S39	231.25 to 447.25
High Band	E21 to E69	471.25 to 855.25 (2)	S40 to S41	455.25 to 463.25

(1). Enough margin is available to tune down to 45.25 MHz.

(2). Enough margin is available to tune up to 863.25 MHz.

Noise	Typ.	Max.	Gain	Min.	Typ.	Max.
Low band	: 6dB	9dB	All Channels	38dB	44dB	50dB
Mid band	: 6dB	10dB	Gain Taper	-	-	8dB
High band	: 6dB	11dB	(off-air channels)			

4. VIDEO SWITCH TEA6415C

In case of three or more external sources are used, the video switch IC TEA6415C is used. The main function of this device is to switch 8 video input sources on the 6 outputs.

Each output can be switched on only one of each input. On each input an alignment of the lowest level of the signal is made (bottom of sync. top for CVBS or black level for RGB signals).

Each nominal gain between any input and output is 6.5dB. For D2MAC or Chroma signal the alignment is switched off by forcing, with an external resistor bridge, 5VDC on the input. Each input can be used as a normal input or as a MAC or Chroma input (with external resistor bridge). All the switching possibilities are changed through the BUS.

Driving 75ohm load needs an external resistor.

It is possible to have the same input connected to several outputs.

5. AM DEMODULATOR TDA9830

The TDA9830 is designed for AM-sound demodulation used in L and L' standard.

Sound IF Input:

The sound IF amplifier consists of three AC-coupled differential amplifier stages each with approximately 20dB gain. At the output of each stage is a multiplier for gain controlling. The overall control range is approximately -6 to +60dB and the frequency response (-3dB) of the IF amplifier is approximately 6 to 70MHz. The steepness of gain control is approximately 10mV/dB.

IF AGC:

The automatic gain control voltage to maintain the AM demodulator output signal at a constant level is generated by a mean level detector. The AGC-detector charges and discharges the capacitor at pin 3 controlled by the output signal of the AM-demodulator compared to an internal reference voltage. The maximum charge/discharge current is approximately 5 mA.

AM-demodulator

The IF amplifier output signal is fed to a limiting amplifier (two stages) and to a multiplier circuit. However the limiter output signal (which is not any more AM modulated) is also fed to the multiplier, which provides AM demodulation (in phase demodulation). After lowpass filtering (fg @ 400kHz) for carrier rejection and buffering, the demodulator output signal is present at pin 6.

Audio Switch

This circuit is an operational amplifier with three input stages and internal feedback network determining gain (0dB) and frequency response (fg @ 700kHz). Two of the input stages are connected to pin 7 and pin 9, the third input stage to an internal reference voltage. Controlled by the switching pins 10 and 12, one of the three input stages can be activated and a choice made between two different AF signals or mute state. The selected signal is present at pin 8. The decoupling capacitors at the input pins are needed, because the internally generated bias voltage for the input stages must not be influenced by the application in order to avoid DC-plop in case of switching.

Reference Circuit:

This circuit is a band gap stabiliser in combination with a voltage regulation amplifier, which provides an internal reference voltage of about 3.6V nearly independent from supply voltage and temperature. This reference voltage is filtered by the capacitor at pin 4 in order to reduce noise. It is used as a reference to generate all important voltages and currents of the circuit. For application in 12V power supply concepts, there is an internal voltage divider in combination with a Darlington transistor in order to reduce the supply voltage for all IC function blocks to approximately 6V.

6. DIGITAL TV SOUND PROCESSOR TDA9875

The TDA9875 is a single-chip Digital TV Sound Processor. Supported standards are M, B/G, D/K, I and L.

Description of the demodulator and decoder section:**SIF Input:**

Two input pins are provided, SIF1 e.g. for terrestrial TV and SIF2 e.g. for a satellite tuner. The selected signal is passed through an AGC circuit and then digitized by an 8-bit ADC operating at 24.576MHz.

AGC:

The gain of the AGC amplifier is controlled from the ADC output by means of a digital control loop employing hysteresis. The AGC has a fast attack behaviour to prevent ADC overloads and slow decay behaviour AGC oscillations. For AM demodulation AGC must be switched off.

Mixer

The digitized input signal is fed to the mixers, which mix one or both input sound carriers down to zero IF. A 24-bit control word for each carrier sets the required frequency.

FM and AM Demodulation

An FM or AM input signal is fed via a band-limiting filter to a demodulator that can be used for either FM or AM demodulation. Apart from the standard (fixed) de-emphasis characteristic, an adaptive de-emphasis is available for encoded satellite programs. A stereo decoder recovers the left and right signal channels from the demodulated sound carriers.

FM Identification:

The identification of the FM sound mode is performed by AM synchronous demodulation of the pilot signal and narrow-band detection of the identification frequencies. The result is available via the I²C-bus interface.

NICAM Demodulation:

The NICAM signal is transmitted in a DQPSK code at a bit rate of 728 kbit/s. The NICAM demodulator performs DQPSK demodulation and feeds the resulting bitstream and clock signal onto the NICAM decoder and, for evaluation purposes, to PCLK (pin 1) and NICAM (pin 2).

NICAM Decoder:

The device performs all decoding functions in accordance with the "EBU NICAM 728 specification". After locking to the frame alignment word, the data is descrambled by applying the defined pseudo-random binary sequence; the device will then synchronise to the periodic frame flag bit C0.

The status of the NICAM decoder can be read out from the NICAM status register by the user. The OSB bit indicates that the decoder has locked to the NICAM data. The VDSP bit indicates that the decoder has locked to the NICAM data and that the data is valid sound data.

7. SOUND OUTPUT STAGE TDA2614/TDA2615/TDA2616Q

TDA2614 is used as the AF output amplifier for mono applications. It is supplied by ± 12 VDC coming from a separate winding in the SMPS transformer. An output power of 2*6W (THD=0.5%) can be delivered into an 8ohm load.

TDA2615 is used as the AF output amplifier for stereo applications. It is supplied by ± 12 VDC coming from a separate winding in the SMPS transformer. An output power of 2*6W (THD=0.5%) can be delivered into an 8ohm load.

TDA2616Q is used as the AF output amplifier for stereo and dolby prologic applications. It is supplied by ± 16 VDC coming from a separate winding in the SMPS transformer. An output power of 2*12W (THD=0.5%) can be delivered into an 8ohm load.

8. VERTICAL OUTPUT STAGE WITH TDA8351/8356

The TDA8351/8356 vertical deflection circuit can be used in 90° and 110° deflection systems with field frequencies from 50 up to 120Hz. With its bridge configuration the deflection output can be DC coupled with few external components. Only a single supply voltage for the scan and a second supply for the flyback are needed. The TDA8356 is intended for 90° systems and the TDA8351 is intended for 110° systems.

The drive voltage is amplified by an amplifier and fed to two amplifiers, one is inverting and the other is a non inverting amplifier. The outputs (pins 7 and 4) are connected to the series connection of the vertical deflection coil and feedback resistor Rsense (R702/R703). The voltage across Rsense is fed via pin 9 to correction amplifier, to obtain a deflection current which is proportional to the drive voltage. The supply voltage for the TDA8351/8356 is 15VDC at pin 3. The supply voltage generator has a separate supply voltage of 45VDC at pin 6.

9. VIDEO OUTPUT AMPLIFIER TDA6107Q

The TDA6107Q consists of three monolithic video output amplifiers. The amplifier can be seen as an operational amplifier with negative feedback.

The advantage of negative feedback is that the amplifier characteristics do not play an important role up to certain frequencies.

The internal flash diodes protect the amplifiers against flash over in the picture tube.

The only protections required at the cathode outputs are a flash resistor and a sparkgap.

The TDA6107Q has an internal thermal protection circuit which gives a decrease of the slew rate at high temperatures.

Furthermore, the device needs only one power supply voltage (Vdd).

In contrast to previous types of DMOS video amplifiers, all the external resistors (Rf, Ri and Ra) are integrated, so the gain is fixed and saves 9 resistors.

Furthermore, the reference voltage is integrated, it saves a resistor divider and a decoupling capacitor. So, the replacement value of the TDA6107Q is very high.

The TDA6107Q is provided with a black current data pin. Since TDA884X is used as drive device, no adjustments are required for gain and black setting, as the TDA884X has I²C white point adjustment and black current set-up.

10. SINGLE/MULTISTANDARD VIF/SIF-PLL and FM-PLL/AM DEMODULATOR TDA9818

The TDA9818 is an IC for multistandard vision IF signal processing, sound AM and FM demodulation.

It is a gain controlled wide band VIF-amplifier (AC-coupled). It is applicable for IF frequencies of 38.9 MHz, 45.75 MHz and 58.75 MHz. True synchronous demodulation is provided with active carrier regeneration. It has a VCO frequency which can be switchable between L and L accent (alignment external) picture carrier frequency.

The TDA9818 has a SIF input for single reference QSS mode (PLL controlled). SIF AGC detector is to provide gain controlled SIF amplifier. The AM demodulator is without extra reference circuit. The supply voltage is +5VDC at pin 21.

11. COMBFILTER SAA4961

The SAA 4961 is a one-chip, PAL/NTSC combfilter IC with internal delay lines, filters, clock control, synchronisation and signal switches. The combfilter function is realised in a switched capacitor technique, so it has time discrete but amplitude continuous processing.

The Y/CVBS input is first clamped and then fed to the delay-line and combfilter section via a low pass pre-filter.

This filter can be bypassed via the external LPF-on pin. This pin is internally pulled up, to put the filter default on. The Y/CVBS input is also fed to the sync separator, where horizontal and vertical reference pulses are made.

Bypass mode can be forced via BYP (pin 3). FSC (pin 1) is the subcarrier input which is connected to the colour decoder.

Input FSCSW pin indicates if fsc or 2*fsc is used.

The Sys1,2 pins (20, 23) indicate which system standard is processed. Sys2 is internally pulled up, Sys1 is internally pulled down. Therefore when the Sys1,2 inputs are left open, automatically PAL 4.43MHz is forced.

SAA4961 output pin 15 "CVBS" can be used for parallel-synced teletext decoders, to guarantee that the teletext display always has a correct timing relation with the main picture. Comb filter is disabled by setting SAA4961 pin 3 "BYP" high.

12. POWER SUPPLY (SMPS)

The DC voltages required at various parts of the chassis are provided by an SMPS transformer controlled by the IC MC44604 which is designed for driving, controlling and protecting switching transistor of SMPS. The transformer produces 150/115V for FBT input, ±14V for audio output IC, S+5V for microcontroller, +15V for vertical output (field scan) and +33V for tuner and some other ICs and transistors.

13. MICROCONTROLLER SDA525X

The device is TV TEXT tuning and control system based on the SDA 525X TV TEXT microcontroller. It is designed for a low cost mono TV-SET with analogue picture and sound control. Nevertheless the system offers an on screen display (OSD) and IR remote control of all functions.

SDA525X has the following features:

- Display of program number, channel number, TV standard, analogue values, sleep timer, parental control, and mute is done by OSD.
- Single LED for IR active, standby and on mode indication.
- 1 Control line to select external source.
- 3 Control lines for TV standard selection.
- Frequency synthesis tuning (62.5 kHz steps)
- 192 step fine tuning
- Channels corresponding to standards B/G, OIRT, L and I (+)
- Mono sound control by analogue voltage
- System configuration with service mode

14. SERIAL ACCESS CMOS 8K (1024*8) EEPROM ST24C08

The ST24C08 is a 8Kbit electrically erasable programmable memory (EEPROM), organised as 4 blocks of 256*8 bits.

The memory is compatible with the I²C standard, two wire serial interface which uses a bi-directional data bus and serial clock.

The memory carries a built-in 4 bit, unique device identification code (1010) corresponding to the I²C bus definition.

This is used together with 1 chip enable input (E) so that up to 2*8K devices may be attached to the I²C bus and selected individually.

15. CLASS AB STEREO HEADPHONE DRIVER TDA1308

The TDA1308 is an integrated class AB stereo headphone driver contained in a DIP8 plastic package.

The device is fabricated in a 1 mm CMOS process and has been primarily developed for portable digital audio applications.

16. SAW FILTERS

Saw filter type : Model:

G1965M	: PAL-SECAM B/G MONO
G3962M	: PAL-SECAM B/G GER&NIC STEREO, PAL I' NIC STEREO, INT-1
G1984	: PAL-SECAM B/G GER&NIC STEREO INT-2
J1951M	: PAL-I MONO
J3950M	: PAL-I NIC STEREO
J1956M	: PAL-I' MONO
K2955M	: PAL-SECAM B/G-D/K MONO, PAL-SECAM B/G-D/K-I', MONO, PAL-SECAM B/G-D/K-L MONO
K2958M	: PAL-SECAM B/G-D/K (38) MONO
K2962M	: PAL-SECAM B/G-L/L' MONO
G3957M	: PAL-SECAM B/G-L/L' GER&NIC BG/L STEREO
K6256K	: PAL-SECAM B/G-D/K-I-L/L' MONO, PAL-SECAM B/G-D/K-I, L/L' GER&NIC BG/L STEREO, PAL-SECAM B/G-D/K-I-L/L' I, NICAM STEREO, PAL-SECAM B/G-D/K-I-L/L' GER&NIC I'-B/G-L, STEREO
K6259K	: PAL-SECAM B/G-D/K-I-M/N (EURO) MONO
M1963M	: PAL M/N MONO, NTSC M MONO, PAL M/N-NTSC M MONO

17. BTSC STEREO/SAP/DBX-DECODER and AUDIO PROCESSOR TDA9855

The TDA9855 is a BTSC stereo/SAP/dbx decoder and audio processor. It performs all functions to transform the composite baseband signal into the appropriate audio output signals to line out and to the loudspeaker output stages.

IC DESCRIPTIONS AND INTERNAL BLOCK DIAGRAM

- TDA8840/8842/8844
- TUNER (UV1315, UV1316, UV1336)
- TEA6415C
- TDA9830
- TDA2614/2615/2616Q
- TDA8351/8356
- TDA6107Q
- SAA4961
- MC44604
- SDA525X
- TDA9875
- TDA9818
- ST24C08
- TDA1308
- G1965M
- TDA9855

TDA8840/8842/8844:

The TDA884X is I²C-bus controlled single chip TV processor which is intended to be applied in PAL, NTSC, PAL/NTSC and multi-standard television receivers. These IC's are nearly pin compatible with the TDA837X TV processors but have a higher degree of integration because the delay line (TDA4665 function) and the SECAM decoder have been integrated. In addition to these functions some additional features have been added like "Continuous Cathode Calibration" (2-point black current loop which results in an accurate biasing of the 3 guns), adjustable luminance delay time, blue stretching and dynamic skin tone control.

Features:

- Vision IF circuit with PLL demodulator
- Alignment-free multi-standard FM sound demodulator (4.5 MHz to 6.5 MHz)
- Audio switch
- Flexible source selection with CVBS switch and Y(CVBS)/C input so that a comb filter can be applied
- Integrated chrominance trap circuit
- Integrated luminance delay line
- Asymmetrical peaking in the luminance channel with a noise coring function
- Black stretching of non-standard CVBS or luminance signals
- Integrated chroma band-pass filter with switchable center frequency
- Blue stretch circuit which offsets colours near white towards blue
- RGB control circuit with "Continuous Cathode Calibration" and white point adjustment
- Linear RGB inputs and fast blanking
- Possibility to insert a "blue black" option when no video signal is available
- Horizontal synchronisation with two control loops and alignment-free horizontal oscillator
- Vertical count-down circuit
- Vertical driver optimised for DC-coupled vertical output stages
- I²C-bus control of various functions
- Low dissipation (850 mW)

Functional Differences between the 8840/8842/8844:

IC VERSION (TDA)	8840	8842	8844
Multi-standard IF		X	X
Automatic Volume Limiting	X	X	
PAL Decoder	X	X	X
SECAM Decoder		X	X
NTSC Decoder		X	X
Dynamic Skin Control			X
Colour Matrix PAL/NTSC (Japan)		X	X
Colour Matrix NTSC Japan/USA			
YUV interface			X
Base-band delay line	X	X	X
Adjustable luminance delay time			X
Horizontal geometry			X
Horizontal and vertical zoom			X
Vertical scroll			X

PINNING

1. Sound IF input
2. External audio input
3. IF demodulator tuned circuit 1
4. IF demodulator tuned circuit 2
5. IF-PLL loop filter
6. IF video output
7. Serial clock input
8. Serial data input/output
9. Bandgap decoupling
10. Chrominance input (S-VHS)
11. External CVBS/Y input
12. Main supply voltage 1
13. Internal CVBS input
14. Ground 1
15. Audio output
16. SECAM PLL decoupling
17. External CVBS input
18. Black-current input

PIN VALUE

- : 1mVrms
- : 500mVrms
- : Min:32-Max:60 MHz
- : 4.7V (Negative Modulation), 2V (Positive Modulation)
- : Low level max:1.5 V, High level min 3.5V
- : Low level max:1.5 V, High level min 3.5V

19. Blue output
20. Green output
21. Red output
22. Beam current limiter input/V-guard input
23. Red input for insertion
24. Green input for insertion
25. Blue input for insertion
26. RGB insertion input
27. Luminance input
28. Luminance output
29. (B-Y) signal output
30. (R-Y) signal output
31. (B-Y) signal input
32. (R-Y) signal input
33. Subcarrier reference output
34. 3.58 MHz crystal connection
35. 4.43/3.58 MHz crystal connection
36. Loop filter phase detector
37. 2nd supply voltage 1
38. CVBS output
39. Decoupling digital supply
40. Horizontal output
41. Flyback input/sandcastle output
42. Phase-2 filter
43. Phase-1 filter
44. Ground 2
45. East-west drive output
46. Vertical drive A output
47. Vertical drive B output
48. IF input 1
49. IF input 2
50. EHT/overvoltage protection input
51. Vertical sawtooth capacitor
52. Reference current input
53. AGC decoupling capacitor
54. Tuner AGC output
55. Audio deemphasis
56. Decoupling sound demodulator

- : 700mVrms, Min:500mVrms, Max:900mVrms
- : Vpp, Max:1.4Vpp
- : Amplitude of "low" reference current : 8mA
- : Amplitude of "high" reference current : 20mA
- : 2Vpp
- : 2Vpp
- : 2Vpp
- : 0.7Vpp, Max:0.8Vpp
- : 0.7Vpp, Max:0.8Vpp
- : 0.7Vpp, Max:0.8Vpp
- : Max:0.3V
- : 1.4Vpp
- : 1.4Vpp
- : 1.05Vpp
- : 1.05Vpp
- : 1.05Vpp
- : 1.05Vpp
- : 3.58/4.43 MHz
- : 8V, Min:7.2V, Max:8.8V
- : 1Vpp, Max:1.4Vpp
- : 1.8V
- : Max: 0.3V
- : Min:100ma, Max:300mA
- : 150 ms/ms
- : ±0.9 kHz, Max: ±1.2 kHz
- : 0.95mA
- : 0.95mA
- : Min:1.2V, Max : 2.8V
- : 3Vpp
- : 3Vpp
- : Max:9V (Maximum tuner AGC Output voltage), 300mV (Output saturation voltage)
- : 500mVrms

UV1315, UV1316, UV1336

General description of UV1315:

The UV1315 tuner belongs to the UV 1300 family of tuners, which are designed to meet a wide range of applications. It is a combined VHF, UHF tuner suitable for CCIR systems B/G, H, L, L', I and I'. The low IF output impedance has been designed for direct drive of a wide variety of SAW filters with sufficient suppression of triple transient.

Features of UV1315:

- Member of the UV1300 family small sized UHF/VHF tuners
- Systems CCIR: B/G, H, L, L', I and I'; OIRT: D/K
- Voltage synthesized tuning (VST)
- Off-air channels, S-cable channels and Hyperband
- Standardized mechanical dimensions and pinning
- Compact size

PINNING	PIN VALUE
1. Gain control voltage (AGC)	: 4.0V, Max:4.5V
2. Tuning voltage	
3. High band switch	: 5V, Min:4.75V, Max:5.5V
4. Mid band switch	: 5V, Min:4.75V, Max:5.5V
5. Low band switch	: 5V, Min:4.75V, Max:5.5V
6. Supply voltage	: 5V, Min:4.75V, Max:5.5V
7. Not connected	
8. Not connected	
9. Not connected	
10. Symmetrical IF output 1	
11. Symmetrical IF output 2	

Bandswitching table:

	Pin 3	Pin 4	Pin 5
Low band	0V	0V	+5V
Mid band	0V	+5V	0V
High band	+5V	0V	0V

General description of UV1316:

The UV1316 tuner belongs to the UV 1300 family of tuners, which are designed to meet a wide range of applications. It is a combined VHF, UHF tuner suitable for CCIR systems B/G, H, L, L', I and I'. The low IF output impedance has been designed for direct drive of a wide variety of SAW filters with sufficient suppression of triple transient.

Features of UV1316:

- Member of the UV1300 family small sized UHF/VHF tuners
- Systems CCIR: B/G, H, L, L', I and I'; OIRT: D/K
- Digitally controlled (PLL) tuning via I²C-bus
- Off-air channels, S-cable channels and Hyperband
- World standardized mechanical dimensions and world standard pinning
- Compact size
- Complies to "CENELEC EN55020" and "EN55013"

PINNING	PIN VALUE
1. Gain control voltage (AGC)	: 4.0V, Max:4.5V
2. Tuning voltage	
3. I ² C-bus address select	: Max:5.5V
4. I ² C-bus serial clock	: Min:-0.3V, Max:5.5V
5. I ² C-bus serial data	: Min:-0.3V, Max:5.5V
6. Not connected	
7. PLL supply voltage	: 5.0V, Min:4.75V, Max:5.5V
8. ADC input	
9. Tuner supply voltage	: 33V, Min:30V, Max:35V
10. Symmetrical IF output 1	
11. Symmetrical IF output 2	

General description of UV1336:

UV1336 series is developed for reception of channels broadcast in accordance with the M, N standard. The tuning is available through built-in digitally controlled I²C bus (PLL).

Features of UV1336:

- Global standard pinning
- Integrated Mixer-Oscillator&PLL function
- Conforms to CISPR 13, FCC and DOC (Canada) regulations
- Low power consumption
- Both Phono connector and 'F' connector are available

PINNING	PIN VALUE
1. Gain control voltage	: 4.0V, Max:4.5V
2. Tuning voltage	
3. Address select	: Max:5.5V
4. Serial clock	: Min:-0.3V, Max:5.5V
5. Serial data	: Min:-0.3V, Max:5.5V
6. Not connected	
7. Supply voltage	: 5.0V, Min:4.75V, Max:5.5V
8. ADC input (optional)	
9. Tuning supply voltage	: 33V, Min:30V, Max:35V
10. Ground	
11. IF output	

TEA6415C:

General Description:

The main function of the TEA6415C is to switch 8 video input sources on the 6 outputs. Each output can be switched to only one of the inputs whereas but any same input may be connected to several outputs. All switching possibilities are controlled through the I²C-bus.

Features:

- 20 MHz Bandwidth
- Cascadable with another TEA6415C (Internal address can be changed by pin 7 voltage)
- 8 inputs (CVBS, RGB, Mac, CHROMA, ...)
- 6 Outputs
- Possibility of MAC or chroma signal for each input by switching-off the clamp with an external resistor bridge
- Bus controlled
- 6.5dB gain between any input and output
- -55dB crosstalk at 5MHz
- Fully ESD protected

PINNING	PIN VALUE
1. Input	: Max : 2Vpp, Input Current : 1mA, Max : 3mA
2. Data	: Low level : -0.3V Max:1.5V, High level : 3.0V Max : Vcc+0.5V
3. Input	: Max : 2Vpp, Input Current : 1mA, Max : 3mA
4. Clock	: Low level : -0.3V Max:1.5V, High level : 3.0V Max : Vcc+0.5V
5. Input	: Max : 2Vpp, Input Current : 1mA, Max : 3mA
6. Input	: Max : 2Vpp, Input Current : 1mA, Max : 3mA
7. Prog	
8. Input	: Max : 2Vpp, Input Current : 1mA, Max : 3mA
9. Vcc	: 12V
10. Input	: Max : 2Vpp, Input Current : 1mA, Max : 3mA
11. Input	: Max : 2Vpp, Input Current : 1mA, Max : 3mA
12. Ground	
13. Output	: 5.5Vpp, Min : 4.5Vpp
14. Output	: 5.5Vpp, Min : 4.5Vpp
15. Output	: 5.5Vpp, Min : 4.5Vpp
16. Output	: 5.5Vpp, Min : 4.5Vpp
17. Output	: 5.5Vpp, Min : 4.5Vpp
18. Output	: 5.5Vpp, Min : 4.5Vpp
19. Ground	
20. Input	: Max : 2Vpp, Input Current : 1mA, Max : 3mA

TDA9830:

General description:

The TDA9830, a monolithic integrated circuit, is designed for AM-sound demodulation used in L- and L'-standard. The IC provides an audio source selector and also mute switch.

Features:

- Adjustment free wideband synchronous AM demodulator
- Audio source-mute switch (low noise)
- Audio level according EN50049
- 5 to 8V power supply or 12 V alternative
- Low power consumption

PINNING	PIN VALUE
1. Sound IF differential input signal	: Minimum IF input signal (between pins 1 and 16):60mV Max:100mV Maximum IF input signal (between pins 1 and 16) :120mV Min :70mV
2. Not connected	
3. AGC capacitor	
4. REF voltage filtering capacitor	
5. Not connected	
6. AM demodulator output	: THD:0.8%, Max:2%; S/N:53dB, Min:47%; DC potential:2.15V, Min : 2.00V Max :2.30V
7. Input signal (from AM) to audio switch	: Max:1.2V
8. Output signal from audio switch	: 80dB, Min : 70dB
9. Input signal (from external) to audio switch	: Max:1.2V

- | | |
|--|---|
| 10. Switch input select control | : Audio switching voltage to activate pin7 : Min :0V, Max :0.8V
Audio switching voltage to activate pin9 : Min:1.5V, Max :Vp |
| 11. Supply voltage | : 12V, Min:10.8V, Max:13.2V |
| 12. Mute control | : For Mute-ON Min : 0V, Max : 0.8V For Mute-OFF Min : 1.5V, Max : Vp |
| 13. Ground | |
| 14. Supply voltage | : 5V, Min : 4.5V, Max : 8.8V |
| 15. Not connected | |
| 16. Sound IF differential input signal | : Look at pin 1 |

TDA2614/TDA2615/TDA2616Q:

General Description of TDA2614:

The TDA2614 is a power amplifier in a 9-lead single-in-line (SIL9) plastic medium power package. It has been especially designed for mains fed applications.

Features:

- Requires very few external components
- No switch-on/switch-off clicks
- Input mute during switch-on and switch-off
- Low offset voltage between output and ground
- Hi-fi in accordance with IEC 268 and DIN 45500
- Short-circuit proof and thermal protected
- Mute possibility

PINNING

PIN VALUE

- | | |
|------------------------------|--|
| 1. Not connected | |
| 2. Mute input | : 300mA (For mute to activate) |
| 3. Ground | |
| 4. Not connected | |
| 5. Supply voltage (negative) | : -12VDC |
| 6. Output | : 6.9Vrms |
| 7. Supply voltage (positive) | : +12VDC |
| 8. Inverting input (Ground) | : 0V |
| 9. Non-inverting input | : 700mVrms, Min : 500mVrms, Max : 900mVrms |

General Description of TDA2615:

The TDA2615 is a dual power amplifier in a 9-lead single-in-line (SIL9). It has been especially designed for mains fed applications.

Features:

- Requires very few external components
- No switch-on/switch-off clicks
- Input mute during switch-on and switch-off
- Low offset voltage between output and ground
- Excellent gain balance of both amplifiers
- Hi-fi in accordance with IEC 268 and DIN 45500
- Short-circuit proof and thermal protected
- Mute possibility

PINNING

PIN VALUE

- | | |
|--------------------------------------|--|
| 1. Non-inverting input 1 | : 700mVrms, Min :500mVrms, Max : 900mVrms |
| 2. Mute input | : 300mA (For mute to activate) |
| 3. Ground | |
| 4. Output 1 | : 6.9Vrms |
| 5. Supply voltage (negative) | : -12VDC |
| 6. Output 2 | : 6.9Vrms |
| 7. Supply voltage (positive) | : +12VDC |
| 8. Inverting inputs 1 and 2 (Ground) | : 0V |
| 9. Non-inverting input 2 | : 700mVrms, Min : 500mVrms, Max : 900mVrms |

General Description of TDA2616Q:

The TDA2616Q is a dual power amplifier. It is supplied in a 9-lead SIL-bent-to DIL plastic power package (SOT157). It has been especially designed for mains fed applications.

Features:

- Requires very few external components
- No switch-on/switch-off clicks
- Input mute during switch-on and switch-off
- Low offset voltage between output and ground
- Excellent gain balance of both amplifiers
- Hi-fi in accordance with IEC 268 and DIN 45500
- Short-circuit proof and thermal protected
- Mute possibility

PINNING

1. Non-inverting input 1	: 700mVrms, Min : 500mVrms, Max : 900mVrms
2. Mute input	: 300mA (For mute to activate)
3. Ground	
4. Output 1	: 9.8Vrms
5. Supply voltage (negative)	: -16VDC
6. Output 2	: 9.8Vrms
7. Supply voltage (positive)	: +16VDC
8. Inverting inputs 1 and 2 (Ground)	: 0V
9. Non-inverting input 2	: 700mVrms, Min : 500mVrms, Max : 900mVrms

PIN VALUE**TDA8351/8356:****General Description:**

The TDA8356 is a power circuit for use in 90° colour deflection system for field frequencies of 50 to 120 Hz.

The circuit operates as a highly efficient class G system.

The TDA8351 is a power circuit for use in 110° colour deflection system for field frequencies of 50 to 120 Hz.

The circuit operates as a highly efficient class G system.

Features:

- Few external components
- Highly efficient fully DC-coupled vertical output bridge circuit
- Vertical flyback switch
- Guard circuit
- Protection against:
 - short-circuit of the output pins (7 and 4)
 - short-circuit of the output pins to Vp
- Temperature (thermal) protection
- High EMC immunity because of common mode inputs
- A guard signal in zoom mode

PINNING

1. Input power-stage (positive); includes li(sb) signal bias	: 400mA, Min : 50mA, Max : 500mA
2. Input power-stage (negative); includes li(sb) signal bias	: 400mA, Min : 50mA, Max : 500mA
3. Operating supply voltage	: +15VDC
4. Output voltage B	: Max : 52V Output current : 2App (TDA8356) 3App (TDA8351)
5. Ground	
6. Input flyback supply voltage	: Min : Vp, Max : 50V
7. Output voltage A	: Max : 52V Output current : 2App (TDA8356) 3App (TDA8351)
8. Guard output voltage	: Max:5.5V (Io:100mA)
9. Input feedback voltage	: Max:52V

PIN VALUE**TDA6107Q:**

The TDA6107Q includes three video output amplifiers in a SIL 9 MP (Single In Line 9 pins Medium Power) package SOT111BE, using high-voltage DMOS technology, and is intended to drive the three cathodes of a colour picture tube.

In contrast to previous types of DMOS video amplifiers, all external resistors (Rf, Ri and Ra) are integrated, so the gain is fixed and it saves 9 resistors.

To obtain maximum performance, the amplifier should be used with black-current control and mounted on the CRT panel.

Features:

- Bandwith: 4.0 MHz typ at 100Vpp (Measured in appli,cation set-up, with Rfl=1K5 and Cl=Ctube+Cpcb=10pF)
- Slewrate: 950V/ms
- Fixed gain of 50 times
- No external components, only the well known supply decoupling
- Very simple application with a variety of colour decoders
- Black-current measurement output for automatic black current stabilization
- Only one supply voltage needed
- Internal protection against positive appearing CRT flash-over discharges
- Protection against ESD
- Internal reference voltage
- Thermal protection
- Controllable switch-off behaviour
- Very small PCB dimensions
- Very high replacement value

PINNING

1. Inverting input 1	: 2Vpp
2. Inverting input 2	: 2Vpp
3. Inverting input 3	: 2Vpp
4. Ground	
5. BSC-output	: Max:7V
6. Supply voltage	: 200VDC
7. Cathode output 3	: 20mA, 100Vpp
8. Cathode output 2	: 20mA, 100Vpp
9. Cathode output 1	: 20mA, 100Vpp

PIN VALUE

SAA4961:

The SAA4961 is an adaptive alignment-free one chip comb filter compatible with both PAL and NTSC systems and provides high performance in Y/C separation.

Features:

- One chip adaptive multi-standard comb filter
- Time discrete but continuous amplitude signal processing with analogue interfaces
- Internal delay lines, filters, clock processing and signal switches
- Alignment-free
- No hanging dots or residual cross colour on vertical transients
- Few external components

It is possible to switch the comb filter into one of the following 3 modes:

1. **Comb mode** : In this mode, luminance and chrominance comb filter function are active.
Chrominance output pin (pin 12) outputs comb filtered chrominance signal, luminance output pin (pin 14) outputs comb filtered luminance signal and CVBS output pin (pin 15) outputs delay compensated CVBS signal.
2. **Comboff mode** : In this mode, luminance comb filter function is turned off, but chrominance comb filter function operates.
Chrominance output pin (pin 12) outputs comb filtered chrominance signal, luminance output pin (pin 14) outputs delay compensated CVBS signal and CVBS output pin (pin 15) outputs delay compensated CVBS signal.
3. **Bypass mode** : In this mode, no IC-function is active. Cext is bypassed to chrominance output pin (pin 12) and Yext/CVBS is bypassed to luminance output pin (pin 14) and CVBS output pin (pin 15).

PINNING

PIN VALUE

1. Subcarrier frequency input	: 200mVpp, Min : 100mVpp, Max : 400mVpp
2. Internal connected	
3. Bypass mode forcing	: HIGH level input voltage Min : 2.4VDC, Max : Vcc
4. Internal connected	
5. Decoupling capacitor	: 1.25VDC, Min : 1.1VDC, Max : 1.4VDC
6. Internal connected	
7. Analogue supply voltage	: 5VDC, Min : 4.75VDC, Max : 5.5VDC
8. Analogue supply voltage output buffer	: 5VDC, Min : 4.75VDC, Max : 5.5VDC
9. Analogue ground	
10. External chrominance input	: 0.7Vpp, Max : 1Vpp
11. Analogue ground output buffer	
12. Chrominance output signal	: 0mV, Min : -400mV, (DC offset voltage related to input) Max : +400mV BYPASS-mode:Co/Cext : 0dB, Min : -1dB, Max : +1dB
13. fsc reference selection	: HIGH level input voltage Min : 2V, Max : Vcc Low level input voltage Min : 0V, Max : 0.8V
14. Luminance output signal	: 1Vpp, Min : 0.6Vpp, Max : 1.54Vpp
15. CVBS and Y output signal	: 1Vpp, Min : 0.6Vpp, Max : 1.54Vpp
16. Internal connected	
17. CVBS and Y input signal	: 1Vpp, Min : 0.7Vpp, Max : 1.4Vpp
18. Disable prefilter	: HIGH level input voltage Min : 2.0VDC, Max : Vcc LOW level input voltage Min : 0VDC, Max : 0.8VDC
19. Storage Capacitor	: 2.5VDC, Min : 1.8VDC, Max : Vcc
20. Standard select 1	: HIGH level input voltage Min : 2.0VDC, Max : Vcc LOW level input voltage Min : 0VDC, Max : 0.8VDC
21. Digital ground	
22. Digital supply voltage	: 5VDC, Min : 4.75VDC, Max : 5.5VDC
23. Standard select 2	: HIGH level input voltage Min : 2.0VDC, Max : Vcc LOW level input voltage Min : 0VDC, Max : 0.8VDC
24. Decoupling capacitor	: 1.25VDC, Min : 1.1VDC, Max : 1.4VDC
25. Controlling I/O pin	: HIGH level input voltage Min : 2.4VDC, Max : Vcc LOW level input voltage Min : 0VDC, Max : 1.5VDC
26. Analogue ground PLL	
27. Analogue supply voltage PLL	: 5VDC, Min : 4.75VDC, Max : 5.5VDC
28. Internal connected	

MC44604:

General description:

The MC44604 is an enhanced high performance controller that is specifically designed for off-line and DC-to-DC converter applications. It offers a really safe and reliable power management thanks particularly to its protection features (foldback, overvoltage detection, soft start, accurate demagnetization detection). Its high current totem pole output is also ideally suited for driving a power MOSFET, but can also be used for driving a bipolar transistor in low power converters. In addition to these features, the MC44604 offers an efficient stand-by mode.

Features:

Current Mode Controller

- Operation up to 250 kHz Output Switching Frequency
- Inherent Feed Forward Compensation
- Latching PWM for Cycle-by-Cycle Current Limiting
- Oscillator with Precise Frequency Control

High Flexibility

- Externally Programmable Reference Current
- Secondary or Primary Sensing
- High Current Totem Pole Output
- Undervoltage Lockout with Hysteresis

Safety/Protection Features

- Overvoltage Protection Facility against Open Loop
- Protection against Short Circuit on Oscillator Pin
- Fully Programmable Foldback
- Soft-Start Feature
- Accurate max Duty Cycle Setting
- Demagnetization (Zero Current Detection) Protection
- Internally Trimmed Reference

“Green Controller”

- Low Start-Up and Operating Current
- Patented Stand-by Pulsed Mode for low stand-by losses
- Low dV/dT for Low EMI radiations

PINNING

PIN VALUE

1. Output Supply Voltage (Vcc)	: 12VDC
2. Output Supply Voltage (Vc)	: 12VDC
3. Output voltage	: LOW Level Drop Voltage 1VDC, Max : 1.2VDC (Isink=100mA) 1.4VDC, Max : 2VDC (Isink=500mA) HIGH Level Drop Voltage 1.5VDC, Max : 2VDC (Isource=200mA) 2VDC, Max : 2.7VDC (Isource=500mA)
4. Ground	
5. Foldback input	: 0.9VDC, Min:-0.3VDC, Max : Vcc+0.3VDC
6. Overvoltage protection (OVP)	: 0.78VDC, Min:-0.3VDC, Max : Vcc+0.3VDC
7. Current sense input	: Min:-0.3VDC, Max : Vcc+0.3VDC
8. Demagnetization detection input	: Idemag-ib (source):-4mA Idemag-ib (sink) : 10mA
9. Standby current set	: Ipeak-stby/Iref : 0.40 Min : 0.37 Max : 0.43
10. Oscillator voltage swing	: 2Vpp
11. Soft start/Dmax/Voltage mode	: Idischarge : 5mA, Min : 1.5mA (Vsoft start=1V)
12. Clamp E/A input	: 4.7VDC, Min : 4.5VDC Max : 4.9VDC
13. E/A output	: HIGH State: 6.5VDC, Min : 5.5VDC, Max : 7.5VDC LOW State : 1.0VDC, 1.1VDC
14. E/A input	: 2.5VDC, Min : 2.4VDC, Max : 2.6VDC
15. Stand-by management	: Stand-by On Detection current ratio : Idet/Iref : 0.38, Min : 0.34, Max : 0.42 Stand-by regulation current ratio : Ireg/Iref : 20.5, Min : 18, Max : 23
16. Rref input	: 2.5VDC, Min : 2.4VDC, Max : 2.6VDC

SDA525X:

General description:

The SDA525X is designed for a low cost mono TV-set with analogue picture and sound control. IN SDA525X the following IC' s are used and supported:

Non-volatile memory	: SDA 2526 or SDA2546
PLL	: SDA 3202-3, SDA 3302
IR transmitter	: SDA 2208-3 or SDA 2218
IR preamplifier	: SFH 506-32

Features:

General:

- Display of program number, channel number, TV standard, analogue values, sleep timer, parental control, and mute is done by OSD
- Single LED for IR active, standby and on mode indication
- Local control (8 keys)
- IR remote control
- Control of volume, contrast, brightness, and saturation by analogue voltages
- Non-volatile memory for 50 or 100 programs, optimum analogue values and system parameters
- Individual delta volume for each program
- 1 control line to select external source
- 3 control lines for TV standard selection
- Automatic muting if no carrier detected
- Automatic switch-off when carrier disappears for more than 5 minutes
- Software protection against tube flashovers with internal watchdog timer
- Sleep timer
- Parental control
- IF 38 MHz or 38.9 MHz selectable

Tuning:

- Frequency synthesis tuning (62.5 kHz steps)
- 192 step fine tuning
- Channels corresponding to standards
- 100 programs selectable by directly entering a program number or by up/down function depending on the NVM size
- Channel selection by directly entering a channel number or by up/down function
- Channel search function in two directions

Sound:

- Mono sound control by analogue voltage

Service Mode:

- System configuration with service mode

PINNING

	PIN VALUE
1. Crystal selection output 1	: LOW level : 0V HIGH level : 4.2V
2. Volume + switch input	: LOW level : 0V HIGH level : 5V
3. Volume - switch input	: LOW level : 0V HIGH level : 5V
4. Program - switch input	: LOW level : 0V HIGH level : 5V
5. Program + switch input:	: LOW level : 0V HIGH level : 5V
6. LED output	: LOW level : 0V HIGH level : 4.2VDC
7. Filter (sound standard) selection output 1	: LOW level : 0V HIGH level : 4.2V
8. Filter (sound standard) selection output 2	: LOW level : 0V HIGH level : 4.2V
9. Mod-switch selection output	: LOW level : 0V HIGH level : 4.2V
10. Ground	
11. Supply voltage	: +5V
12. 18 MHz crystal connection 1	: 2Vpp
13. 18 MHz crystal connection 2	: 2Vpp
14. L-ACC output	: LOW level : 0V HIGH level : 3.6V
15. RESET output	: LOW level : 0V HIGH level : 5V
16. Comb filter PAL/SECAM selection output	: LOW level : 0V HIGH level : 5V
17. Tuning output	: LOW level : 0V HIGH level : 3.4V
18. Audio switch transistor selection 1	: LOW level : 0V HIGH level : 5V
19. Audio switch transistor selection 2	: LOW level : 0V HIGH level : 5V
20. Audio switch transistor selection 3	: LOW level : 0V HIGH level : 5V
21. Audio switch transistor selection 4	: LOW level : 0V HIGH level : 5V
22. Comb filter standard selection 1	: LOW level : 0V HIGH level : 5V
23. Comb filter standard selection 2	: LOW level : 0V HIGH level : 5V
24. Analogue ground	
25. Filter 3	
26. Filter 2	
27. Filter 1	
28. Analogue supply voltage	: 5VDC
29. Reference current input	
30. CVBS input	: 1Vpp
31. Service output	: LOW level : 0V HIGH level : 5V
32. AV2-status input	: LOW level : 0V HIGH level : 5V
33. AV1-status input	: LOW level : 0V HIGH level : 5V
34. AFC output	: 600mVpp
35. Ground	
36. IR-input	: LOW level : 0V HIGH level : 5V
37. Supply voltage	: 5V
38. LC input	: 5Vpp
39. LC output	: 5Vpp
40. Mute output	: LOW level : 0V HIGH level : 4.2V
41. St-by output	: LOW level : 0V HIGH level : 1.4V
42. Clock signal output	
43. Data output	
44. Local connection	: LOW : 0V HIGH : 5V
45. SAND input	: 4Vpp
46. ODD/EVEN output	: 1.8V
47. OSD-red output	: LOW level : 0V HIGH level : 5V
48. OSD-green output	: LOW level : 0V HIGH level : 5V
49. OSD-blue output	: LOW level : 0V HIGH level : 5V
50. OSD-blanking output	: LOW level : 0Vh HIGH level : 5V
51. COR output	: LOW level : 0V HIGH level : 5V
52. Crystal selection output 2	: LOW level : 0V HIGH level : 4.2V

TDA9875:

General description:

The TDA9875 is a single-chip Digital TV Sound Processor (DTVSP) for analogue and digital multi-channel sound systems.

Features:

Demodulator and decoder section:

- Sound IF (SIF) input switch e.g. to select between terrestrial TV SIF and SAT SIF sources
- SIF AGC with 21dB control range
- SIF 8-bit Analogue-to-Digital Converter (ADC)
- DQPSK demodulation for different standards, simultaneously with 1-channel FM demodulation
- NICAM decoding (B/G, I and L standard)
- Two-carrier multistandard FM demodulation (B/G, D/K and M standard)
- Decoding for three analogue multi-channel systems (A2, A2+ and A2*) and satellite sound
- Optional AM demodulation for system L, simultaneously with NICAM
- Programmable identification (B/G, D/K and M standard) and different identification times

DSP section:

- Digital crossbar switch for all digital signal sources and destinations
- Control of volume, balance, contour, bass, treble, pseudo stereo, spatial, bass boost and soft-mute
- Plop-free volume control
- Automatic Volume Level (AVL) control
- Adaptive de-emphasis for satellite
- Programmable beeper
- Monitor selection for FM/AM DC values and signals, with peak detection option
- I²S-bus interface for a feature extension (e.g. Dolby surround) with matrix, level adjust and mute.

Analogue audio section:

- Analogue crossbar switch with inputs for mono and stereo, SCART 1 input/output, SCART2 input/output and line output
- User defined full-level/-3dB scaling for SCART outputs
- Output selection of mono, stereo, dual A/B, dual A or dual B
- 20 kHz bandwidth for SCART-to-SCART copies
- Standby mode with functionality for SCART copies
- Dual audio digital-to-analogue converter from DSP to analogue crossbar switch, bandwidth 15kHz
- Dual audio ADC from analogue inputs to DSP
- Two dual audio Digital-to-Analogue Converters (DACs) for loudspeakers (Main) and headphone (Auxiliary) outputs; also applicable for L, R, C and S in the Dolby Pro Logic mode with feature extension.

PINNING

1. NICAM clock output (728kHz)

2. Serial NICAM DATA output (728kHz)

3. First I²C-bus slave address modifier

4. SCL (I²C-bus clock)

5. SDA (I²C-bus data)

6. Analogue supply ground 1

7. Analogue supply voltage 1

8. Resistor for reference current generator

9. First general purpose I/O pin

10. Sound IF input 2

11. Reference voltage for demodulator part

12. Sound IF input 1

13. Second I²C-bus slave address modifier

14. Digital supply ground 1

15. Digital supply voltage 1

16. Capacitor for power-on reset

17. Crystal oscillator output

18. Crystal oscillator input

19. Tuning voltage output for crystal oscillator

20. Second general purpose I/O pin

21. System clock output

22. I²S-bus clock

23. I²S-bus word select

24. I²S-bus data output 2

25. I²S-bus data output 1

26. I²S-bus data input 2

27. I²S-bus data input 1

28. First test pin; connected to ground for normal operation

29. Audio mono input

30. Second test pin; connected to ground for normal operation

31. External audio input right channel

PIN VALUE

: LOW level input voltage : Max : 0.8V

HIGH level input voltage : Min : 2.0V

: LOW level input voltage : Max : 0.8V

HIGH level input voltage : Min : 2.0V

: LOW level input voltage : Max : 0.8V

HIGH level input voltage : Min : 2.0V

: LOW level input voltage : Max : 1.6V

HIGH level input voltage : Min : 3.0V

: LOW level input voltage : Max : 0.8V

HIGH level input voltage : Min : 2.0V

: 0V

: 5V, Min : 4.75V, Max : 5.5V

: I_{ref} : 220mA, Min : 170mA, Max : 260mA

: Min : 21V_{rms}, Max : 250mV_{rms}

: V_{dda1}/V_{ssa1} : 50%, Min : 35%, Max : 65%

: Min : 21V_{rms}, Max : 250mV_{rms}

: LOW level input voltage : Max : 0.8V

HIGH level input voltage : Min : 2.0V

: 0V

: 5V, Min : 4.75V, Max : 5.5V

: LOW level input voltage : Max : 1.6V

HIGH level input voltage : Min : 3.0V

: LOW level input voltage : Max : 0.5V

HIGH level input voltage : Min : 2.9V

: LOW level input voltage : Max : 0.8V

HIGH level input voltage : Min : 2.0V

: LOW level input voltage : Max : 0.8V

HIGH level input voltage : Min : 2.0V

: LOW level input voltage : Max : 0.8V

HIGH level input voltage : Min : 2.0V

: LOW level input voltage : Max : 0.8V

HIGH level input voltage : Min : 2.0V

: LOW level input voltage : Max : 0.8V

HIGH level input voltage : Min : 2.0V

: LOW level input voltage : Max : 0.8V

HIGH level input voltage : Min : 2.0V

: LOW level input voltage : Max : 0.8V

HIGH level input voltage : Min : 2.0V

: 500mV_{rms}

: 350mV_{rms}

32. External audio input left channel	: 350mVrms
33. SCART 1 input right channel	: 350mVrms
34. SCART 1 input left channel	: 350mVrms
35. Ground guards	
36. SCART 2 input right channel	: 350mVrms
37. SCART 2 input left channel	: 350mVrms
38. Analogue supply voltage 2	: 5V, Min : 4.75V, Max : 5.5V
39. Positive reference voltage	
40. Reference voltage ground	: 0V
41. Filter capacitor pin 1	
42. Filter capacitor pin 2	
43. Analogue supply ground 2	: 0V
44. Filter capacitor pin 2	
45. Filter capacitor pin 1	
46. Reference voltage 2	: Vdda2/Vssa2 : 50%
47. Scart 1 output right channel	: 500mVrms
48. Scart 1 output left channel	: 500mVrms
49. Digital supply ground 2	: 0V
50. Analogue supply ground 4	: 0V
51. Scart 2 output right channel	: 500mVrms
52. Scart 2 output left channel	: 500mVrms
53. Reference voltage 3	: Vdda3/Vssa3:50%
54. Post-filter capacitor pin right channel	
55. Post-filter capacitor pin left channel	
56. Analogue supply ground 3	: 0V
57. Headphone output right channel	: Vo(clip) : Min : 1400mVrms
58. Headphone output left channel	: Vo(clip) : Min : 1400mVrms
59. Analogue supply voltage 3	: 5.0V, Min : 4.75V, Max : 5.5V
60. Loudspeaker (main) output right channel	: Vo(clip) : Min : 1400mVrms
61. Loudspeaker (main) output left channel	: Vo(clip) : Min : 1400mVrms
62. Line output left channel	: 500mVrms
63. Line output right channel	: 500mVrms
64. Digital supply voltage 2	: 5.0V, Min : 4.75V, Max : 5.5V

TDA9818:

General description:

The TDA9818 is an integrated circuit for multistandard vision IF signal processing, sound AM and FM demodulation.

Features:

- 5 V supply voltage
- Applicable for IF frequencies of 38.9 MHz, 45.75 MHz and 58.75 MHz
- Gain controlled wide band VIF-amplifier (AC-coupled)
- True synchronous demodulation with active carrier regeneration (very linear demodulation, good intermodulation figures, reduced harmonics, excellent pulse response)
- Robustness for overmodulation better than 105% due to gated phase detector at L/L accent standard and PLL-bandwidth control at negative modulated standards
- VCO frequency switchable between L and L accent (alignment external) picture carrier frequency
- VIF AGC detector for gain control, operating as peak sync detector for B/G, peak white detector for L; signal controlled reaction time for L
- Tuner AGC with adjustable takeover point (TOP)
- AFC detector without extra reference circuit
- AC-coupled limiter amplifier for sound intercarrier signal
- Alignment-free FM-PLL demodulator with high linearity
- SIF input for single reference QSS mode (PLL controlled); SIF AGC detector for gain controlled SIF amplifier; single reference QSS mixer able to operate in high performance single reference QSS mode and in intercarrier mode
- AM demodulator without extra reference circuit
- Stabilizer circuit for ripple rejection and to achieve constant output signals
- ESD protection for all pins

PINNING

	PIN VALUE
1. VIF differential input signal voltage 1	: Input signal voltage sensitivity 60mVrms, Max:100mVrms
2. VIF differential input signal voltage 2	: Input signal voltage sensitivity 60mVrms, Max:100mVrms
3. Standard switch	: Min : 2.8V, Max : Vp
4. VIF AGC capacitor	: Charging current : 1mA, Min : 0.75mA, Max : 1.25mA Discharging current : B/G standard : 20mA, Min : 15mA, Max:25mA Normal mode L : 300nA, Min : 225nA, Max : 375nA Fast mode L : 40mA, Min : 30mA, Max : 50mA
5. SIF AGC capacitor	: Charging current : FM mode : 12mA, Min : 8mA, Max : 16mA AM mode : 1.2mA, Min : 0.8mA, Max : 1.6mA Discharging current : FM mode : 12mA, Min : 8mA, Max : 16mA Normal mode AM : 1.4mA, Min : 1mA, Max : 1.8mA Fast mode AM : 85mA, Min : 60mA, Max : 110mA
6. PLL loop filter	: Min : 0V, Max : Vp
7. L/L accent switch and adjust	: Min : 0V, Max : Vp
8. Audio output	: Rx : 470ohm : 250mVrms, Min : 200mVrms, Max : 300mVrms Rx : 0ohm : 500mVrms, Min : 400mVrms, Max : 600mVrms
9. De-emphasis input	: Min : 0V, Max : Vp
10. De-emphasis output	: Min : 0V, Max : Vp
11. Decoupling capacitor	: Min : 0V, Max : Vp
12. Single reference QSS/intercarrier output voltage	: 140mVrms, Min : 100mVrms Max : 180mVrms

13. Sound intercarrier input voltage	: Input signal voltage for lock-in: Max : 100mVrms Input signal voltage : 250mVrms
14. Tuner AGC output	: IF input signal voltage for minimum starting point of tuner takeover 2mV, Max : 5mV IF input signal voltage for maximum starting point of tuner takeover 100mV, Min : 50mV
15. Black level detector	: Min : 0V; Max : Vp
16. Composite video output voltage	: 1.1Vpp, Min : 0.97Vpp, Max : 1.23Vpp
17. AFC output	: Upper limit : Vp-0.3V, Min : Vp-0.6V, Lower limit : 0.3V, Max : 0.6V
18. VCO1 resonance circuit	
19. VCO2 resonance circuit	
20. Ground	: 0V
21. Supply voltage	: 5V, Min : 4.5V, Max : 5.5V
22. Tuner AGC takeover adjust (TOP)	
23. SIF differential input signal voltage 1	: Input signal voltage sensitivity 50mVrms, Max : 100mVrms
24. SIF differential input signal voltage 2	: Input signal voltage sensitivity 50mVrms, Max : 100mVrms

ST24C08:

General description:

The ST24C08 is a 8Kbit electrically erasable programmable memory (EEPROM), organized as 4 blocks of 256 * 8 bits. The memory operates with a power supply value as low as 2.5V. Both Plastic Dual-in-Line and Plastic Small Outline packages are available.

Features:

- Minimum 1 million ERASE/WRITE cycles with over 10 years data retention
- Single supply voltage: 4.5 to 5.5V
- Two wire serial interface, fully I²C-bus compatible
- Byte and Multibyte write (up to 8 bytes)
- Page write (up to 16 bytes)
- Byte, random and sequential read modes
- Self timed programming cycle

PINNING

1. Write protect enable (Ground)
2. Not connected (Ground)
3. Chip enable input (Ground)
4. Ground
5. Serial data address input/output
6. Serial clock
7. Multibyte/Page write mode
8. Supply voltage

PIN VALUE

- : 0V
- : 0V
- : 0V
- : 0V
- : Input LOW voltage : Min : -0.3V, Max : 0.3*Vcc
Input HIGH voltage: Min : 0.7*Vcc, Max : Vcc+1
- : Input LOW voltage : Min : -0.3V, Max : 0.3*Vcc
Input HIGH voltage: Min : 0.7*Vcc, Max : Vcc+1
- : Input LOW voltage : Min : -0.3V, Max : 0.5V
Input HIGH voltage: Min : Vcc-0.5, Max : Vcc+1
- : Min : 2.5V, Max : 5.5V

TDA1308:

Features:

- Wide temperature range
- No switch ON/OFF clicks
- Excellent power supply ripple rejection
- Low power consumption
- Short-circuit resistant
- High performance
 - high signal-to-noise ratio
 - high slew rate
 - low distortion
- Large output voltage swing

PINNING

1. Output A (Voltage swing)
2. Inverting input A
3. Non-inverting input A
4. Ground
5. Non-inverting input B
6. Inverting input B
7. Output B (Voltage swing)
8. Positive supply

PIN VALUE

- : Min : 0.75V, Max : 4.25V
- : Vo(clip) : Min : 1400mVrms
- : 2.5V
- : 0V
- : 2.5V
- : Vo(clip) : Min : 1400mVrms
- : Min : 0.75V, Max : 4.25V
- : 5V, Min : 3.0V, Max : 7.0V

G1965M:

Features:

- TV IF filter with Nyquist slope and sound shelf at typ. 20.4dB
- High colour carrier level at typ. 1.0dB
- Constant group delay
- Insertion attenuation typ. 15.0dB

PINNING

1. Input
2. Input-ground
3. Chip carrier-ground

TDA9855

General description:

The TDA9855 is a bipolar-integrated BTSC stereo/SAP decoder with hi-fi audio processor (I²C-bus controlled) for application in TV sets.

Features:

- Quasi alignment-free BTSC stereo decoder due to auto adjustment of channel separation via I²C-bus
- High integration level with automatically tuned integrated filters
- Input level adjustment I²C-bus controlled
- Alignment-free Sap processing
- dbx noise reduction circuit
- Audio processor
 - Selector for internal and external signals (line in)
 - Automatic volume level control
 - Subwoofer or surround output with separate volume control
 - Volume control
 - Special loudness characteristic automatically controlled in combination with volume setting
 - Bass and treble control
 - Audio signal zero crossing detection between any volume step switching
 - Mute control at audio signal zero crossing
 - I²C-bus transceiver.

PINNING

PIN VALUE

1. Treble control capacitor, left channel	
2. Bass control capacitor, left channel	
3. Bass control capacitor, left channel	
4. Not connected	
5. Programmable address bit (module address)	
6. Output, left channel	: 500mVrms, Min : 480mVrms, Max : 520mVrms
7. Input loudness, left channel	
8. Input volume control, left channel	: 2.15Vrms, Min : 2Vrms
9. Output effects, left channel	
10. Automatic volume control capacitor	
11. Reference voltage 0.5Vcc	: 4VDC
12. Line input, left channel	: 2.3Vrms, Min : 2Vrms
13. Input automatic volume control, left channel	: Min : 2Vrms
14. Output selector, left channel	
15. Line output, left channel	: 500mVrms
16. Capacitor timing wideband for dbx	
17. Capacitor timing spectral for dbx	
18. Capacitor wideband for dbx	
19. Capacitor spectral for dbx	
20. Variable emphasis out for dbx	
21. Variable emphasis in for dbx	
22. Capacitor noise reduction for dbx	
23. Capacitor mute for SAP	
24. Capacitor DC decoupling for SAP	
25. Common ground	: 0V
26. Serial data input/output	: High level input voltage: Min : 3VDC, Max : Vcc Low level input voltage: Min : -0.3VDC, Max : 1.5VDC Low level output voltage : Max : 0.4VDC
27. Serial clock input	: High level input voltage: Min : 3VDC, Max : Vcc Low level input voltage : Min : -0.3VDC, Max : 1.5VDC Low level output voltage : Max : 0.4VDC
28. Supply voltage	: 8VDC
29. Input composite signal	: 250mVrms
30. Capacitor for electronic filtering of supply	
31. Capacitor for pilot detector	
32. Capacitor for pilot detector	
33. Capacitor for phase detector	
34. Capacitor for filter adjust	
35. Ceramic resonator	
36. Capacitor DC decoupling mono	
37. Capacitor DC decoupling stereo/SAP	
38. Line output, right channel	: 500mVrms
39. Output selector, right channel	
40. Input automatic volume control, right channel	: Min:2Vrms
41. Line input, right channel	: 2.3Vrms, Min : 2Vrms
42. Capacitor 2 pseudo function	
43. Capacitor 1 pseudo function	
44. Output effects, right channel	
45. Input volume control, right channel	: Min : 2Vrms
46. Input loudness, right channel	
47. Output, right channel	: 500mVrms, Min : 480mVrms, Max : 520mVrms
48. Not connected	
49. Filter capacitor for subwoofer	
50. Bass control capacitor, right channel	
51. Bass control capacitor, right channel	
52. Treble control capacitor	

AK19 CHASSIS MANUAL ADJUSTMENTS PROCEDURE

In order to enter the service menu, first enter the installation menu and then press the digits 4, 7, 2 and 5 respectively.

For ADJUST settings:

Select **Adjust** using ∇ or \triangle button and press \triangleright or \triangleleft button to enter it. To select different adjust parameters, use ∇ or \triangle button. To change the selected parameter, use \triangleright or \triangleleft button.

WHITE BALANCE ADJUSTMENT:

The following three parameters are used to make white balance adjustment. To do this, use a Colour Analyser. Using white point RED, white point GREEN and white point BLUE parameters, insert the + sign in the square which is in the middle of the screen.

ADJUST 00 = White Point RED

ADJUST 01 = White Point GREEN

ADJUST 02 = White Point BLUE

AGC ADJUSTMENT:

In order to do AGC adjustment, enter a 60dBmV RF signal level from channel C-12.

Connect a digital voltmeter to pin 1 of the tuner. Change the AGC parameter until you see 3.70VDC on voltmeter display. Check that picture is normal at 90dBmV signal level.

ADJUST 03 = AGC

IF-PLL NEGATIVE ADJUSTMENT (Only with PLL tuner):

Connect 38.9 MHz test pattern for PAL B/G, PAL-SECAM B/G, 39.5 MHz test pattern for PAL I or 45.75 MHz test pattern for PAL M/N, NTSC M model to Z401 SAW filter input terminals. Change the IF-PLL Negative parameter until you see IN, DOWN below. If you cannot catch IN, DOWN position this way, using a screwdriver rotate the VIF-COIL LT401 left or right until you see IN, DOWN.

ADJUST 04 = IF-PLL Negative

IF-PLL POSITIVE ADJUSTMENT (Only with PLL tuner):

Connect 33.9 MHz test pattern for SECAM L' model to Z401 SAW filter input terminals. Change the IF-PLL Positive parameter until you see IN, DOWN below. If you cannot catch IN, DOWN position this way, using a screwdriver rotate the VIF-COIL LT401 left or right until you see IN, DOWN.

ADJUST 05 = IF-PLL Positive

LUMINANCE DELAY ADJUSTMENT (with only TDA 8844 video processor):

ADJUST 06 = Y-Delay PAL

Enter a PAL B/G colour and black-white bar test pattern via RF. Adjust Y-Delay PAL till the colour transients on the colour bar of the pattern become as sharper and colours between transients do not mix with each other as possible.

Note: If the SAW filter is one of the G1965M, J1951M, J3950M, K2958M, K2962M, G3957M, K6256K, K6259K or M1963M, there is constant group delay distortion, so for an equal delay of the luminance and chrominance signal the delay must be set at a value of 160nS. This means the adjustment must be set to the maximum value.

ADJUST 07 = Y-Delay SECAM

Enter a SECAM B/G colour and black-white bar test pattern via RF. Adjust Y-Delay SECAM till the colour transients on the colour bar of the pattern become as sharper and colours between transients do not mix with each other as possible.

Note: If the SAW filter is one of the G1965M, K2958M, K2962M, G3957M, K6256K or K6259K, there is constant group delay distortion, so for an equal delay of the luminance and chrominance signal the delay must be set at a value of 160nS.

This means the adjustment must be set to the maximum value.

ADJUST 08 = Y-Delay NTSC

Enter an NTSC colour and black-white bar test pattern via RF. Adjust Y-Delay NTSC till the colour transients on the colour bar of the pattern become as sharper and colours between transients do not mix with each other as possible.

Note: If the SAW filter is M1963M, there is constant group delay distortion, so for an equal delay of the luminance and chrominance signal the delay must be set at a value of 160nS. This means the adjustment must be set to the maximum value.

ADJUST 09 = Y-Delay Other

In case of other colour systems, enter this system with colour and black-white bar test pattern via RF. Adjust Y-Delay Other till the colour transients on the colour bar of the pattern become as sharper and colours between transients do not mix with each other as possible. Normally for an equal delay of the luminance and chrominance signal the delay must be set at a value of 160nS.

This means the adjustment must be set to the maximum value.

VERTICAL ZOOM ADJUSTMENT (only for 110ø picture tubes):

ADJUST 10 = Vertical Zoom

Enter a PAL B/G circle test pattern via RF. Change vertical zoom till you see the upper and lower limit of the circle as close to the upper and lower limit of the picture tube as possible.

VERTICAL SCROLL ADJUSTMENT (only for 110ø picture tubes):

ADJUST 11 = Vertical Scroll

Enter a PAL B/G circle test pattern via RF. Change vertical scroll till you see the circle exactly in the middle of the screen.

4:3 HORIZONTAL SHIFT ADJUSTMENT:

ADJUST 12 = 4 : 3 Horizontal Shift

Enter a RED PURITY test pattern via RF. Change horizontal shift till the picture is horizontally centred. Check whether this adjustment is correct after completing Service Mode Adjustment.

4:3 VERTICAL SLOPE ADJUSTMENT:

ADJUST 13 = 4 : 3 Vertical Slope

Enter a CROSS-HATCH B/G test pattern via RF. Change vertical slope till the size of squares on both the upper and lower part of test pattern become equal to the squares laying on the vertical centre of the test pattern. Check and readjust VERTICAL SLOPE item if the adjustment becomes improper after some other geometric adjustments are done.

4:3 VERTICAL AMPLITUDE ADJUSTMENT:**ADJUST 14 = 4 : 3 Vertical Amplitude**

Enter a PAL B/G test pattern via RF. Change vertical slope till horizontal black lines on both the upper and lower part of the test pattern become very close to the upper and lower horizontal sides of picture tube and nearly about to disappear. Check and readjust VERTICAL AMPLITUDE item if the adjustment becomes improper after some other geometric adjustments are done.

4:3 S-CORRECTION ADJUSTMENT:**ADJUST 15 = 4 : 3 S-Correction**

Enter a PAL B/G circle test pattern via RF. Change S-correction till the middle part of the circle is as round as possible.

4:3 VERTICAL SHIFT ADJUSTMENT:**ADJUST 16 = 4 : 3 Vertical Shift**

Enter a PAL B/G test pattern via RF. Change Vertical Shift till the test pattern is vertically centred, i.e. horizontal line at the centre pattern is in equal distance both to upper and lower side of the picture tube. Check and readjust Vertical Shift item if the adjustment becomes improper after some other geometric adjustments are done.

4:3 EW WIDTH ADJUSTMENT (only for 110ø picture tubes):**ADJUST 17 = 4 : 3 EW Width**

Enter a PAL B/G test pattern via RF. Change EW Width till the vertical black and white bars on both left and right side of the pattern exactly disappear.

4:3 EW PARABOLA WIDTH ADJUSTMENT (only for 110ø picture tubes):**ADJUST 18 = 4 : 3 EW Parabola Width**

Enter a PAL B/G test pattern via RF. Change EW Parabola Width till vertical lines close to the both sides of the picture frame become parallel to vertical sides of picture tube. Check and readjust EW Parabola Width item if the adjustment becomes improper after some other geometric adjustments are done.

4:3 EW CORNER PARABOLA ADJUSTMENT (only for 110ø picture tubes):**ADJUST 19 = 4 : 3 EW Corner Parabola**

Enter a PAL B/G test pattern via RF. Change EW Corner Parabola till vertical lines at the corners of both sides of picture frame become vertical and parallel to vertical corner sides of picture tube. Check and readjust EW Corner Parabola item if the adjustment becomes improper after some other geometric adjustments are done.

4:3 EW TRAPEZIUM ADJUSTMENT (only for 110ø picture tubes):**ADJUST 20 = 4 : 3 EW Trapezium**

Enter a PAL B/G test pattern via RF. Change EW Trapezium till vertical lines, especially lines at the sides of the picture frame become parallel to the both sides of picture tube as close as possible. Check and readjust EW Trapezium item if the adjustment becomes improper after some other geometric adjustments are done.

16:9 HORIZONTAL SHIFT ADJUSTMENT:**ADJUST 21 = 16 : 9 Horizontal Shift**

Enter a RED PURITY test pattern via RF. Change horizontal shift till the picture is horizontally centred. Check whether this adjustment is correct after completing Service Mode Adjustment.

16:9 VERTICAL SLOPE ADJUSTMENT:**ADJUST 22 = 16 : 9 Vertical Slope**

Enter a CROSS-HATCH B/G test pattern via RF. Change vertical slope till the size of squares on both the upper and lower part of test pattern become equal to the squares laying on the vertical centre of the test pattern. Check and readjust VERTICAL SLOPE item if the adjustment becomes improper after some other geometric adjustments are done.

16:9 VERTICAL AMPLITUDE ADJUSTMENT:**ADJUST 23 = 16 : 9 Vertical Amplitude**

Enter a PAL B/G test pattern via RF. Change vertical slope till horizontal black lines on both the upper and lower part of the test pattern become very close to the upper and lower horizontal sides of picture tube and nearly about to disappear. Check and readjust VERTICAL AMPLITUDE item if the adjustment becomes improper after some other geometric adjustments are done.

16:9 S-CORRECTION ADJUSTMENT:**ADJUST 24 = 16 : 9 S-Correction**

Enter a PAL B/G circle test pattern via RF. Change S-correction till the middle part of the circle is as round as possible.

16:9 VERTICAL SHIFT ADJUSTMENT:**ADJUST 25 = 16 : 9 Vertical Shift**

Enter a PAL B/G test pattern via RF. Change Vertical Shift till the test pattern is vertically centred, i.e. horizontal line at the centre pattern is in equal distance both to upper and lower side of the picture tube. Check and readjust Vertical Shift item if the adjustment becomes improper after some other geometric adjustments are done.

16:9 EW WIDTH ADJUSTMENT (only for 110ø picture tubes):**ADJUST 26 = 16 : 9 EW Width**

Enter a PAL B/G test pattern via RF. Change EW Width till the vertical black and white bars on both left and right side of the pattern exactly disappear.

16:9 EW PARABOLA WIDTH ADJUSTMENT (only for 110ø picture tubes):**ADJUST 27 = 16 : 9 EW Parabola Width**

Enter a PAL B/G test pattern via RF. Change EW Parabola Width till vertical lines close to the both sides of the picture frame become parallel to vertical sides of picture tube. Check and readjust EW Parabola Width item if the adjustment becomes improper after some other geometric adjustments are done.

16:9 EW CORNER PARABOLA ADJUSTMENT (only for 110ø picture tubes):**ADJUST 28 = 16 : 9 EW Corner Parabola**

Enter a PAL B/G test pattern via RF. Change EW Corner Parabola till vertical lines at the corners of both sides of picture frame become vertical and parallel to vertical corner sides of picture tube. Check and readjust EW Corner Parabola item if the adjustment becomes improper after some other geometric adjustments are done.

16:9 EW TRAPEZIUM ADJUSTMENT (only for 110ø picture tubes):**ADJUST 29 = 16 : 9 EW Trapezium**

Enter a PAL B/G test pattern via RF. Change EW Trapezium till vertical lines, especially lines at the sides of the picture frame became parallel to the both sides of picture tube as close as possible. Check and readjust EW Trapezium item if the adjustment becomes improper after some other geometric adjustments are done.

For OPTION settings:

Select **OPTION** using ▽ or △ button and press ▷ or ◁ button to enter it. To select different option bytes, use ▽ or △ button. Using ▷ or ◁ button select the bit you want to set and then set it pressing 0 or 1 button.

OPTION 00**B7B6B5B4B3B2B1B0**B7 = Ina : X (Note 1) (**don' t care**)B6 = Inb : X (Note 1) (**don' t care**)B5 = Inc : X (Note 1) (**don' t care**)

B4 = Akb : 0 (Auto Kine Biasing, 1=disable black current stabilisation loop, 0=enable)

B3 = Foa : X (Note 2) (**don' t care**)B2 = Fob : X (Note 2) (**don' t care**)

B1 = Xa : Note 3

B0 = Xb : Note 3

Note 1:

Ina, Inb, Inc bits: Input Source Select Switch. This determines which signal is displayed and which is available at CVBSout pin 38. This output can be connected to teletext, the TDA8395 SECAM add-on or a comb filter. There are two special positions, where the output of pin 38 can be fed through the comb filter, back into the Y and C input pins 11 and 10.

I NA	INB	INC	Selected Video Source	Selected Audio	CVBS switch output (Pin 38)
0	0	0	CVBS1int pin 13	Internal (Note a)	CVBS1int
0	0	1	CVBS2ext pin 17	External pin 2	CVBS2ext
0	1	0	Ys-vhs, Cs-vhs pins 11, 10	External pin 2	Y and C added to CVBS
0	1	1	CVBS3ext pin 11	External pin 2	CVBS3ext
1	0	0	Ys-vhs, Cs-vhs pins 11, 10	Internal (Note a)	CVBS1int
1	1	0	Ys-vhs, Cs-vhs pins 11, 10	External pin 2	CVBS2ext

Note a:

Positive Modulation (MOD=1) selects pin 2 for (AM demodulated) sound input.

Note 2:

FOA, FOB bits: Ö1 time constant : These two bits determine the speed of the Ö1-loop. It can be forced to slow and fast or set it in the automatic mode. In auto mode a noise detector circuit can switch to slow time constant, when the signal has too much noise.

FOA	FOB	Ö1-loop mode
0	0	Auto, Ö1-gating in slow mode (Note b)
0	1	Slow, always gating
1	0	Slow/fast depends on noise detector, always gating
1	1	Fast, no gating

Note b:

Not suitable for weak video recorder signals, because of active Ö1-gating in the slow mode. Use **FOA, FOB=1,1** instead.

Note 3:

Xa, Xb

0,1 : PAL M, Pal N, NTSC M

Pin 34 : 3.58 (1, 2 or 3 crystals)

Pin 35 : No crystal

1,0 : PAL B/G, PAL D/K, Pal I/I+, SECAM B/G, SECAM D/K, SECAM

L/L', SECAM K1

Pin 34 : No crystal

Pin 35 : 4.43 (1 Crystal)

1,1 : PAL B/G, PAL D/K, Pal I/I+, SECAM B/G, SECAM D/K, SECAM

L/L', SECAM K1, PAL M, PAL N, NTSC M

Pin 34 : 3.58 (1, 2 or 3 Crystals)

Pin 35 : 4.43 (1 Crystal)

OPTION 01

B7B6B5B4B3B2B1B0

B7 = Forf : 1 (Note 1)

B6 = Fors : 1 (Note 1)

B5 = DL : X (De-interlace: 0= Interlace, 1= De-interlace) (**don' t care**)

B4 = STB : X (Stand-by) (0= TDA884X in standby mode, 1= IC operational) (**don' t care**)

B3 = Poc : X (Synchronisation mode: 0=Synchronization active, 1=Synchronisation: not active) (**don' t care**)

B2 = Cm2 : X (Note2) (**don' t care**)

B1 = Cm1 : X (Note2) (**don' t care**)

B0 = Cm0 : X (Note2) (**don' t care**)

Note1:

Forf, Fors bits: Forced field frequency: This forces the vertical divider in a 60 Hz mode or automatic. In auto mode it can be given a preference for 50 or 60 Hz or to keep the last detected field frequency.

FORF	FORS	Vertical Frequency
0	0	Auto, 60 Hz if not locked
0	1	60 Hz forced (Note c)
1	0	Auto, keep last detected frequency
1	1	Auto, 50 Hz if not locked

Note c: When already locked at 50 Hz, 60 Hz is forced after sync loss.

Note2:

Cm2, Cm1, Cm0 bits: Colour Decoder Mode: With these bits the automatic mode can be selected or the decoder can be forced to one of the standards. Xtal selection bits **XA** and **XB** should not be contradictory to a forced Xtal selection in the colour decoder mode (e.g. force pin 35 while there is only a Xtal on pin 34).

CM2	CM1	CM0	Colour Decoder Mode
0	0	0	Automatic, own intelligence, 2 Xtals
0	0	1	Forced Xtal pin 34, PAL/NTSC
0	1	0	Forced Xtal pin 34, PAL
0	1	1	Forced Xtal pin 34, NTSC
1	0	0	Forced Xtal pin 35, PAL/NTSC (Note d)
1	0	1	Forced Xtal pin 35, PAL
1	1	0	Forced Xtal pin 35, NTSC
1	1	1	Forced Xtal pin 35, SECAM

Note d: In this mode, the colour oscillator is forced to use one Xtal pin, while the decoder can select PAL or NTSC automatically.

OPTION 02

B7B6B5B4B3B2B1B0

B7 = Oso : 0 (Over-scan Switch-Off: 0= Switch-off undefined, 1= Switch-off in vertical overscan)

B6 = Vsd : 0 (Vertical Scan Disable: 0=Active Vertical Scan, 1= Disable Vertical Scan)

B5 = Cb : 0 (Chroma Band pass center frequency: 0= Centre frequency at Fsc (chroma sub-carrier frequency), 1= Center frequency at 1.1*Fsc)

B4 = Bls : 0 (Blue Stretch: 0= Blue Stretch off, 1= Blue Stretch on)

B3 = Bks : 0 (Black Stretch: 0= Black Stretch off, 1= Black Stretch on)

B2 = Ie1 : X (Insertion Enable Fast blanking: 1= enable RGB insertion, 0= disable) (**don' t care**)

B1 = Afw : X (AFC Window around IF center frequency: 0= Nominal window, about 80 kHz wide; 1= Enlarged window, about 240 kHz wide) (**don' t care**)

B0 = Bb : 0 (Blue Background: 0= Normal operation, 1= Blue background active)

OPTION 03

B7B6B5B4B3B2B1B0

B7 = Hob: Note1

B6 = Bps: 0 (Bypass chroma delay line: 0 Chroma delay line active, 1= Delay line bypassed)

B5 = Acl: X (Automatic Colour Limiting: 0= ACL not needed for standard burst/chroma transmissions; 1= ACL active, for non standard chroma-to-burst ratio) (**don' t care**)

B4 = Cmb: Note2

B3 = Ast: X (Abs-loop Start-up mode: 0=Automatic mode, RGB drive switches on when ABS loop stable; 1= Switch-on under control of micro controller) (**don' t care**)

B2 = CL2: 1 (Note3)

B1 = CL1: 1 (Note3)

B0 = CL0: 0 (Note3)

Note1:

0 = Pal+ helper output blanking disabled

1 = Pal+ helper output blanking enabled

Note2: Comb Filter

0 = Pin 33 Low, comb filter off

1 = Sub-carrier output pin 33 active, comb filter on

Note3:

CL2,CL1,CL0 bits: Cathode drive level:

CL2	CL1	CL0	Variation Cathode Drive Level
0	0	0	Minimum
0	0	1	+ 14 %
0	1	0	+ 28 %
0	1	1	+ 42 %
1	0	0	+ 57 %
1	0	1	+ 71 %
1	1	0	+ 85 %
1	1	1	+ 100 %

OPTION 04

B7B6B5B4B3B2B1B0

B7 = lfs: X (If sensitivity: 0= Normal Sensitivity, 1= Maximum gain reduced by 20 dB (reduces the total gain range)) (don' t care)

B6 = Mod : X (Modulation standard: 0 = Negative Modulation, 1 = Positive Modulation, AM demodulated sound can be connected to pin 2) (don' t care)

B5 = VSW: X (Video Mute Switch : 0= Normal Operation, 1= IF Video signal switched off (pin 6 is forced to ground)) (don' t care)

B4 = Sm: X (Sound mute of internal FM demodulator: 0 = Normal Operation, 1 = Sound Muted) (don' t care)

B3 = Ds: 0 (Dynamic Skin Control: 1= on, 0= off)

B2 = Dsa: 0 (Dynamic Skin Control Angle: 1= 123 degrees, 0 = 118 degrees)

B1 = Fav: 0 (Fixed Audio Volume: 0= Volume controlled front-end or external audio output at pin 15, 1= Fixed front-end audio output at pin 15)

B0 = Lfa: X (Secam L1 Frequency Adjust: 0= Normal IF Frequency, 1 = IF Frequency shifted for L1 standard (align with IFPL) (don' t care)

OPTION 05

B7B6B5B4B3B2B1B0

B7 = Avl: 0 (Automatic Volume Levelling: 1= active, 0= disabled)

B6 = Hbl: X (Wider Horizontal Blanking: 1= blank left+right edges, 0= normal blanking on H-flyback pulse) (don' t care)

B5 = Vim: X (Video Ident Mode: 1= Coupled to Source Switch, 0= to IF) (don' t care)

B4 = Gai: X (Gain of luminance channel: 0= Normal gain of luminance channel (V27 =1Vblack-white) (When CTI is disabled), 1= High Gain for Luminance Input (When CTI is enabled) (V27=0.45Vpp))

B3 = Ncin: X (Vertical Divider Mode: 0=Normal operation of the vertical divider, 1 = Vertical divide switched to large search window) (don' t care))

B2 = Strm: X (Search Tuning Mode: 0= Normal operation, 1= Reduced Sensitivity of coincidence detector) (don' t care)

B1 = Vid: X (Video Ident Mode: 1= No influence, 0= IFI contols Ö1- loop) (don' t care)

B0 = Lbm: 0 (Long blanking mode: 0= Blanking adapted to standard (50 or 60 Hz), 1= Fixed blanking according 50 Hz standard)

OPTION 06

B7B6B5B4B3B2B1B0

B7 = Hco: X (EHT Tracking mode: 0= EHT tracking only on vertical, 1 = EHT tracking on both vertical and East-West) (don' t care)

B6 = EVG: 0 (Enable Vertical Guard: 0= Only vertical guard detection (Output bit NDF), 1= Detection (NDF) and protection by blanking RGBout

B5 = SBL: X (Service Blanking: 0= No service blanking, 1= Service Blanking active) (don' t care)

B4 = Prd: X (Over-voltage protection input mode: 0= Only over-voltage detection (output bit XPR), 1= Over- voltage detection (XPR) and inhibit horizontal drive (protection)) (don' t care)

B3 = Mat: 0 (TDA8840/4142/44 : PAL/NTSC matrix: 0 = Matrix adapted to standard (Japanese NTSC matrix or PAL matrix), 1= Forced to PAL matrix)

B2 = Rbl: X (RGB Blanking: 0= Normal picture visible, 1= RGBout (pins 21, 20, 19) blanked) (don' t care)

B1 = Cor: X (Noise coring: 0= Noise coring off; 1= Noise coring on, reduce peaking function on small transients) (don' t care)

B0 = Aen: (Enable APS: 0= APS disabled >> Preset, 1= APS enabled >> No Preset)

OPTION 07

B7B6B5B4B3B2B1B0

B7 = C3: Note1

B6 = C2: Note1

B5 = C1: Note1

B4 = C0: Note1

B3 = CL: Note2

B2 = Tr: Note3

B1 = L1: Note4

B0 = L0: Note4

Note1:

C3, C2, C1, C0 : These bits define country:

0, 0, 0, 0 = ? : Not allowed

0, 0, 0, 1 = D: Germany

0, 0, 1, 0 = A: Austria

0, 0, 1, 1 = CH: Switzerland

0, 1, 0, 0 = I: Italy

0, 1, 0, 1 = F: France

0, 1, 1, 0 = B: Belgium

0, 1, 1, 1 = DK: Denmark

1, 0, 0, 0 = S: Sweden

1, 0, 0, 1 = N: Norway
1, 0, 1, 0 = SF: Finland
1, 0, 1, 1 = GB: Great Britain
1, 1, 0, 0 = NL: Netherlands
1, 1, 0, 1 = P: Portugal
1, 1, 1, 0 = E: Spain
1, 1, 1, 1 = TR: Turkey

Note2:

CL : This bit enables or disables Child Lock function.

0= Off

1= On (Active)

Note3:

Tr : This bit enables or disables Turkish language usage.

0= Disabled (3 Languages: English, German and French)

1= Enabled (4 Languages: English, German, French and Turkish)

Note4:

L1, L0 : These bits select menu language:

0, 0 = English

0, 1 = German

1, 0 = French

1, 1 = Turkish

OPTION 08

B7B6B5B4B3B2B1B0

B7 = Tub : (Tube size: 0= 16 : 9 Tube size, 1= 4 : 3 Tube size)

B6 = Tun : **don' t care**

B5 = IfD: Note1

B4 = IfI: Note2

B3 = IfM: Note3

B2 = APS: (To determine whether APS will run at first turning on the TV or not: 0= APS done, 1= APS set)

B1 = Hp: (To enable Headphone: 0= No Headphone, 1= Headphone available)

B0 = Hue: (In case of NTSC system to enable Hue function: 0= No Hue, 1= Hue Available)

Note1:

IfD

0 = If DK 38.0 MHz

1 = If DK 38.9 MHz

Note2:

IfI

0 = IfI 39.5 MHz (Great Britain I, **Only UHF Tuner**)

1 = IfI 38.9 MHz (Ireland I+, **Standard Tuner**)

Note3:

IfM

0 = If M, N 45.75 MHz S&N American Models, **Tuner UV1336** (Only PAL M, Pal N, NTSC M)

1 = If M, N 38.9 MHz Euro M, N Models, **Standard Tuner**

OPTION 09

B7B6B5B4B3B2B1B0

B7 = NM: (NTSC M) Note1

B6 = PN: (PAL N) Note1

B5 = PM: (PAL M) Note1

B4 = K1: Note1

B3 = L: Note1

B2 = I: Note1

B1 = DK: Note1

B0 = BG: Note1

Note1:

0 = Standard not supported

1 = Standard available

OPTION 10

B7B6B5B4B3B2B1B0

B7 = Txt: **don' t care**

B6 = Weu: Note1

B5 = E/T: Note1

B4 = Com: (Enable Comb Filter: 0= Comb filter not supported, 1 = Comb filter available)

B3 = SvH: (Enable S-VHS Input: 0= S-VHS not supported, 1 = S-VHS available)

B2 = Fro: (Enable Front-AV (AV-3): 0= Front-AV (AV-3) not supported, 1 = Front AV (AV-3) available)

B1 = Sc2: (Enable Scart2 (AV-2): 0= Scart2 (AV-2) not supported, 1 = Scart2 (AV2) available)

B0 = Sc1: (Enable Scart1 (AV-1): 0= Scart1 (AV-1) not supported (Not a real case), 1= Scart1 (AV-1) available)

Note1: Weu,E/T: Teletext character set table selection

0, 0 = West Europe+Turkish

0, 1 = East Europe

1, 0 = West Europe

1, 1 = West Europe

GENERAL BLOCK DIAGRAM OF CHASSIS AK19

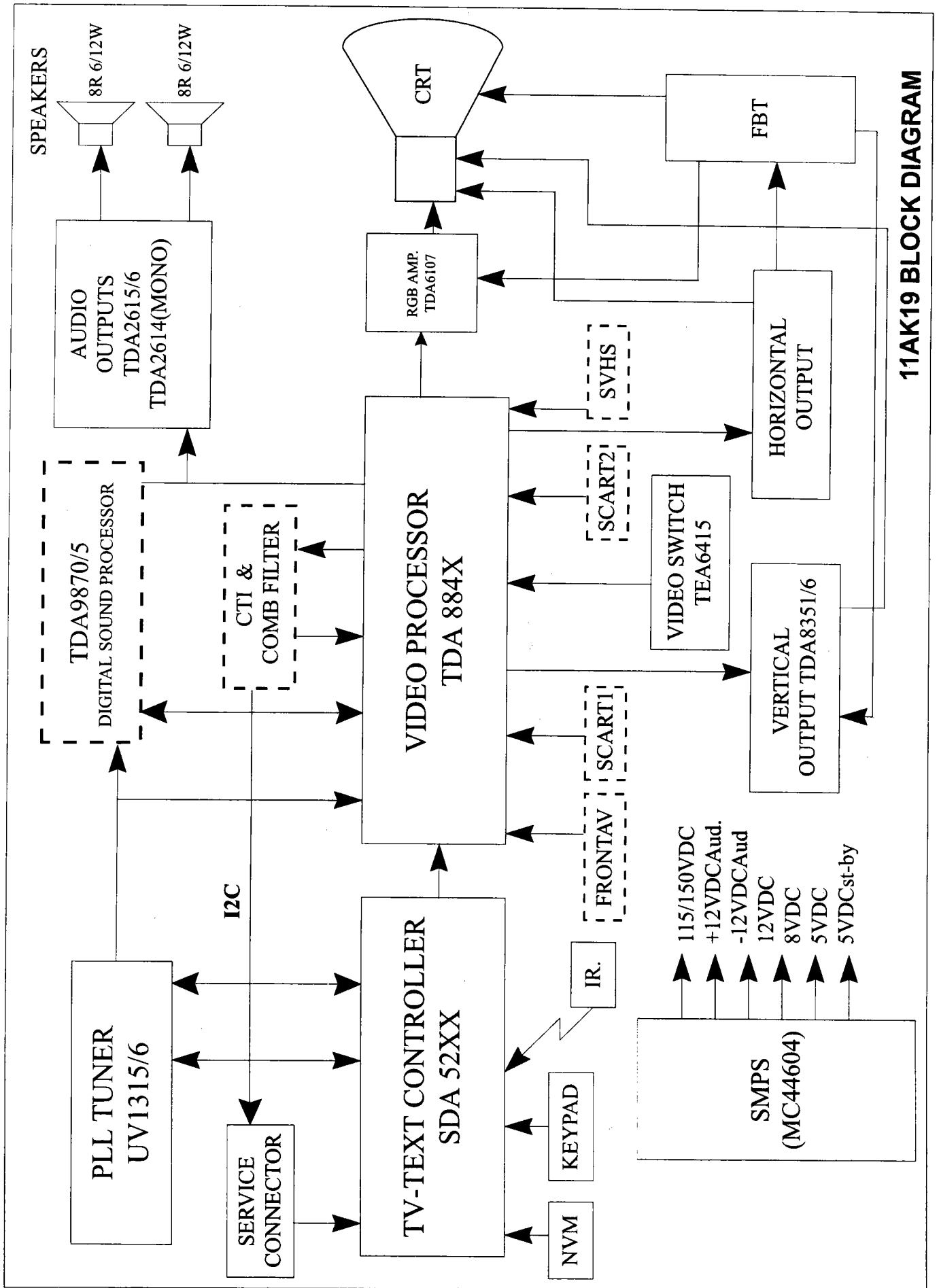

ELECTRONIC COMPONENTS PART LIST

POZ.NO	VESKOD	DESCRIPTION	POZ.NO	VESCOD	DESCRIPTION
	1005017350	CHS.ASSY.19-19GF32122133231	C373	3081010356	CAP EL 100UF 16V M
	1007204050	R/C 2040 (NOBRAND)	C374	3081010356	CAP EL 100UF 16V M
	1010000535	SPK.ASSY.5X/54/55 19ST 2/60	C426	3081010456	CAP EL 100UF 25V M
	2002500200	FUSE ASSY.TK79-A (2.5A)	C848	3081010456	CAP EL 100UF 25V M
IC804	2006505080	HEATSINK ASSY.16/19-REG(2)	C612	3081011054	CAP EL 100UF 63V M
	2006505200	HEATSINK ASSY.19-CRT BOARD	C702	3081011054	CAP EL 100UF 63V M
	2006505220	HEATSINK ASSY.19-REG&STR	C817	3081020354	CAP EL 1000UF 16V M
	2006505230	HEAT.A.19-HOR&VER BAV&EXT.90ø	C820	3081020354	CAP EL 1000UF 16V M
	2006505250	HEAT.ASSY.19-SMPS 90ø170-270V	C828	3081020354	CAP EL 1000UF 16V M
	2042202060	S.B.ST19-BG/L GS+NI HP FAV	C632	3081020454	CAP EL 1000UF 25V M
	2046400700	BAV B.ASSY.BAV19A-BAV/OUT	C335	3081090856	CAP EL 1UF 50V M
	2052500680	JACK B.ASSY.HP19SB STEREO	C375	3081090856	CAP EL 1UF 50V M
	2052500940	FAV B.ASSY.FAV-19 STR	C431	3081090856	CAP EL 1UF 50V M
	2942202003	S.B.ST19-BG/L GS+NI	C516	3082200856	CAP EL 22UF 50V M
	2942202008	S.B.ST19-HEADPHONE	C413	3082210356	CAP EL 220UF 16V M
	2942202009	S.B.ST19-FRONT AV	C814	3082210356	CAP EL 220UF 16V M
	2946400005	BAV B.ASSY.BAV19-BAV OUT	C845	3082210356	CAP EL 220UF 16V M
C705	3011031036	CAP MKT 10NF 63V J	C847	3082210356	CAP EL 220UF 16V M
C403	3011041036	CAP MKT 100NF 63V J	C823	3082220454	CAP EL 2200UF 25V M
C435	3011041036	CAP MKT 100NF 63V J	C826	3082220454	CAP EL 2200UF 25V M
C436	3011041036	CAP MKT 100NF 63V J	C308	3082290856	CAP EL 2.2UF 50V M
C483	3011041036	CAP MKT 100NF 63V J	C309	3082290856	CAP EL 2.2UF 50V M
C709	3011041036	CAP MKT 100NF 63V J	C310	3082290856	CAP EL 2.2UF 50V M
C807	3011041036	CAP MKT 100NF 63V J	C311	3082290856	CAP EL 2.2UF 50V M
C605	3011041548	CAP MKT 100NF 250V K DL	C347	3082290856	CAP EL 2.2UF 50V M
C901	3011041548	CAP MKT 100NF 250V K DL	C348	3082290856	CAP EL 2.2UF 50V M
C801	3011041558	CAP MKT 100NF 250V M AC	C364	3082290856	CAP EL 2.2UF 50V M
C802	3011041558	CAP MKT 100NF 250V M AC	C365	3082290856	CAP EL 2.2UF 50V M
C707	3012231136	CAP MKT 22NF 100V J	C407	3082290856	CAP EL 2.2UF 50V M
C051	3012241036	CAP MKT 220NF 63V J	C437	3082290856	CAP EL 2.2UF 50V M
C053	3012241036	CAP MKT 220NF 63V J	C101	3083300856	CAP EL 33UF 50V M
C054	3012241036	CAP MKT 220NF 63V J	C102	3083300856	CAP EL 33UF 50V M
C071	3012241036	CAP MKT 220NF 63V J	C330	3083300856	CAP EL 33UF 50V M
C415	3012241036	CAP MKT 220NF 63V J	C449	3083300856	CAP EL 33UF 50V M
C706	3012241036	CAP MKT 220NF 63V J	C601	3083300856	CAP EL 33UF 50V M
C518	3013331036	CAP MKT 33NF 63V J	C606	3083301354	CAP EL 33UF 160V M
C519	3013331036	CAP MKT 33NF 63V J	C500	3083390856	CAP EL 3.3UF 50V M
C522	3013331036	CAP MKT 33NF 63V J	C618	3083391356	CAP EL 3.3UF 160V M
C854	3013331036	CAP MKT 33NF 63V J	C201	3084700856	CAP EL 47UF 50V M
C304	3013341036	CAP MKT 330NF 63V J	C301	3084700856	CAP EL 47UF 50V M
C316	3013341036	CAP MKT 330NF 63V J	C307	3084700856	CAP EL 47UF 50V M
C318	3013341036	CAP MKT 330NF 63V J	C312	3084700856	CAP EL 47UF 50V M
C319	3013341036	CAP MKT 330NF 63V J	C315	3084700856	CAP EL 47UF 50V M
C322	3013341036	CAP MKT 330NF 63V J	C505	3084700856	CAP EL 47UF 50V M
C323	3013341036	CAP MKT 330NF 63V J	C829	3084701358	CAP EL 47UF 160V M (HR)
C327	3013341036	CAP MKT 330NF 63V J	C607	3084710354	CAP EL 470UF 16V M
C328	3013341036	CAP MKT 330NF 63V J	C114	3084710854	CAP EL 470UF 50V M
C332	3013341036	CAP MKT 330NF 63V J	C115	3084710854	CAP EL 470UF 50V M
C521	3013341036	CAP MKT 330NF 63V J	C813	3084720354	CAP EL 4700UF 16V M
C604	3014731036	CAP MKT 47NF 63V J	C340	3084790856	CAP EL 4.7UF 50V M
	3014731136	CAP MKT 47NF 100V J	C432	3084790856	CAP EL 4.7UF 50V M
C112	3014741036	CAP MKT 470NF 63V J	C804	3101511955	CAP EL 150UF 400V M
C113	3014741036	CAP MKT 470NF 63V J	C846	3201021156	CAP CER 1NF 1KV M B
C113	3014741036	CAP MKT 470NF 63V J	C850	3201021156	CAP CER 1NF 1KV M B
C704	3014741036	CAP MKT 470NF 63V J	C851	3201021156	CAP CER 1NF 1KV M B
C610	3031043038	CAP MKP 100NF 250V J	C852	3201021156	CAP CER 1NF 1KV M B
C833	3032215048	CAP MPP 0.22NF 630V K	C903	3201024148	CAP CER 1NF 2KV K B
C811	3034735038	CAP MKP 47NF 630V J	C860	3202227458	CAP CER 2.2NF 4KV M
C617	3035643038	CAP MKP 560NF 250V J	C821	3204711146	CAP CER 470PF 1KV KB
C611	3037827078	CAP MKP 7.8NF 1.6KV 3.5%	C824	3204711146	CAP CER 470PF 1KV KB
C808	3061020146	CAP CER 1NF 50V K B	C827	3204711146	CAP CER 470PF 1KV KB
C809	3061020146	CAP CER 1NF 50V K B	R332	3311211030	RES SMD 1/10W 120R J (0805)
C855	3061020146	CAP CER 1NF 50V K B	R587	3311220437	RES CF 1/4W 1.2K J
C853	3061030396	CAP CER 10NF 50V Z F	R901	3311520237	RES CF 1/2W 1.5K J
C380	3061040396	CAP CER 100NF 50V Z F	R902	3311520237	RES CF 1/2W 1.5K J
C816	3061040396	CAP CER 100NF 50V Z F	R903	3311520237	RES CF 1/2W 1.5K J
C819	3061040396	CAP CER 100NF 50V Z F	R905	3311520237	RES CF 1/2W 1.5K J
C822	3061040396	CAP CER 100NF 50V Z F	R906	3311520237	RES CF 1/2W 1.5K J
C825	3061040396	CAP CER 100NF 50V Z F	R816	3311550237	RES CF 1/2W 1.5M J (400V)
C830	3061040396	CAP CER 100NF 50V Z F	R860	3312250237	RES CF 1/2W 2.2M J (400V)
C832	3061040396	CAP CER 100NF 50V Z F	R457	3312251030	RES SMD 1/10W 2.2M J
C406	3062230396	CAP CER 22NF 50V Z F	R620	3351020237	RES MO 1/2W 1K J
C904	3062724146	CAP CER 2.7NF 500V K B	R630	3351020237	RES MO 1/2W 1K J
C608	3063330146	CAP CER 33NF 50V K B	R610	3352222137	RES MO 2W 2.2K J
C806	3068210146	CAP CER 820PF 50V K B	R806	3352232137	RES MO 2W 22K J
C068	3081000856	CAP EL 10UF 50V M	R822	3352233137	RES MO 22K 3W J
C102	3081000856	CAP EL 10UF 50V M	R870	3353381134	RES MO 1W 0.33R J
C203	3081000856	CAP EL 10UF 50V M	R704	3361010437	RES FUSE 1/4W 100R J
C204	3081000856	CAP EL 10UF 50V M	R611	3361091137	RES FUSE 1W 1R J
C402	3081000856	CAP EL 10UF 50V M	R628	3362700237	RES FUSE 1/2W 27R J
C405	3081000856	CAP EL 10UF 50V M	R845	3374750237	RES MG 1/2W 4.7M J
C410	3081000856	CAP EL 10UF 50V M	R817	3382295130	RES WW 5W 2.2R J RAD.
C428	3081000856	CAP EL 10UF 50V M	TH801	3391803000	THERM.PTC DEGAUSS DUAL 250V
C440	3081000856	CAP EL 10UF 50V M	LD501	3519029300	LED RED/GREEN LTL293SJ
C507	3081000856	CAP EL 10UF 50V M	D301	3520501350	DIODE VAR BB135
C514	3081000856	CAP EL 10UF 50V M	D201	3531941480	DIODE 1N4148

POZ.NO	VESKOD	DESCRIPTION
C517	3081000856	CAP EL 10UF 50V M
C570	3081000856	CAP EL 10UF 50V M
C580	3081000856	CAP EL 10UF 50V M
C625	3081001454	CAP EL 10UF 250V M
C902	3081001454	CAP EL 10UF 250V M
C028	3081010356	CAP EL 100UF 16V M
C100	3081010356	CAP EL 100UF 16V M
C336	3081010356	CAP EL 100UF 16V M
D509	3531941480	DIODE 1N4148
D510	3531941480	DIODE 1N4148
D602	3531941480	DIODE 1N4148
D603	3531941480	DIODE 1N4148
D607	3531941480	DIODE 1N4148
D608	3531941480	DIODE 1N4148
D701	3531941480	DIODE 1N4148
D823	3531941480	DIODE 1N4148
D816	3551500261	DIODE BYM26D
D814	3551500953	DIODE BYW95A
D815	3551500953	DIODE BYW95A
D811	3551900331	DIODE BYD33D
D812	3551900331	DIODE BYD33D
D813	3551900331	DIODE BYD33D
D605	3551901570	DIODE BA157
D606	3551901570	DIODE BA157
D609	3551901570	DIODE BA157
D601	3551901590	DIODE BA159
D805	3551901590	DIODE BA159
D807	3551901590	DIODE BA159
D818	3551901590	DIODE BA159
D826	3551901590	DIODE BA159
D827	3551901590	DIODE BA159
D801	3551940070	DIODE 1N4007
D802	3551940070	DIODE 1N4007
D803	3551940070	DIODE 1N4007
D804	3551940070	DIODE 1N4007
D901	3551940070	DIODE 1N4007
D902	3551940070	DIODE 1N4007
D903	3551940070	DIODE 1N4007
D408	3570008200	DIODE ZENER 8.2V
D819	3570011000	DIODE ZENER 11V
D505	3571903600	DIODE ZENER 3.6V ZPD
D604	3571933000	DIODE ZENER 33V UZT 33B
Q810	3610902260	TR MCR22-6
Q802	3610936000	TR MTP3N60E
Q303	3611502400	TR BF240
Q604	3611506390	TR BC639
Q605	3611525060	TR 2506DF
IC303	3620040530	IC HEF4053BP (MN4053B)
IC807	3620078050	IC LM78M05 BIG
IC802	3620946040	IC MC44604P
IC805	3620978080	IC LM7808
IC801	3621100800	IC CQY80NG (OPT.COUPLER)
Q809	3621104310	IC TL431
IC305	3621513080	IC TDA1308
IC100	3621526150	IC TDA2615
IC901	3621561070	IC TDA6107Q/N1C
IC701	3621583560	IC TDA8356
IC401	3621588420	IC TDA8842
IC302	3621598180	IC TDA9818
IC301	3621598750	IC TDA9875
	3621624080	IC ST24C08
IC050	3621664150	IC TEA6415C
	3621678050	IC L7805CV SGS
IC501	3621852551	IC SDA5255 (AK19) PLL/ATS
	3622408000	IC 24C08 001155B10011510200
MD501	3660536000	PREAMPLIFIER TFMS5360
Z300	3750239530	FILTER SAW OFWK3953M
Z401	3750239530	FILTER SAW OFWK3953M
Z301	3750294540	FILTER SAW L9454
Z209	3780105550	FILTER SER TRAP TPS 5.5MHZ
	3807250050	FUSE 2.5A 250V 5*20MM
X301	3840124510	XTAL 24.576MHZ
X401	3840144310	XTAL 4.433619 MHZ
X501	3840418020	REZ 18MHZ
PL100	3861200204	CONN.MALE 2P (2052) GRAY
PL101	3861200206	CONN.MALE (2052) BLACK
PL056	3861200211	CONN.MALE 2P (2052) BLUE
PL058	3861200301	CONN.MALE 3P (2003) GRAY
PL059	3861200303	CONN.MALE 3P (2003) BLUE
PL303	3861200307	CONN.MALE 3P(2703) RED
PL304	3861200308	CONN MALE 3P(2703) GREEN
PL304	3861200308	CONN MALE 3P(2703) GREEN
PL050	3861200501	CONN.MALE 5P (2005)
PL801	3861500200	CONN.MALE 2P MOLEX
	3861500201	CONN.FEMALE 2P MLX
PL403	3861501201	CONN.MALE 12P MOLEX
PL301	3861501202	CONN.FEMALE 12P MOLEX

POZ.NO	VESCOD	DESCRIPTION
D302	3531941480	DIODE 1N4148
D303	3531941480	DIODE 1N4148
D420	3531941480	DIODE 1N4148
D503	3531941480	DIODE 1N4148
D504	3531941480	DIODE 1N4148
D506	3531941480	DIODE 1N4148
D507	3531941480	DIODE 1N4148
D508	3531941480	DIODE 1N4148
PL404	3861501401	CONN.MALE 14P MOLEX
PL302	3861501402	CONN.FEMALE 14P MOLEX
PL601	3861820406	HRZ VRT CONN.(4P)
PL900	3862021001	SOCKET CRT NARROWNECK W/GND
SC050	3862050004	SOCKET SCART (R)
SC051	3862050004	SOCKET SCART (R)
PL113	3863010315	JACK RCA 3P (BACK AV) 180°
PL1204	3863011021	RCA JACK 1P WHITE (180°)
PL1205	3863011022	RCA JACK 1P RED (180°)
PL1203	3863011023	RCA JACK 1P YELLOW (180°)
PL102	3863120300	JACK HEADPHONE STEREO WO/SW
TU201	3924224317	TUNER WSP (PLL) 38.9 MK2
	3962112128	CRT 21/VCL A51EFS83X191
	3970801505	SPEAKER 8R15W (77*128)
L309	4010000025	FERRITE BEAD (0805) BLM21B201S
L306	4010000032	FERRITE BEAD (805) BLM21A601S
L307	4010000032	FERRITE BEAD (805) BLM21A601S
L201	4011104512	FIXED COIL 1UH Q45 M-A
L312	4011104512	FIXED COIL 1UH Q45 M-A
L801	4011225511	FIXED COIL 2.2UH Q55 M-AX
L301	4011336522	FIXED COIL 3.3UH Q65 K
L402	4011336522	FIXED COIL 3.3UH Q65 K
L302	4011477022	FIXED COIL 4.7UH Q70 K-A
L303	4011477022	FIXED COIL 4.7UH Q70 K-A
L304	4011477022	FIXED COIL 4.7UH Q70 K-A
L305	4011477022	FIXED COIL 4.7UH Q70 K-A
L501	4011685026	FIXED COIL 6.8UH K RAD
L403	4011687522	FIXED COIL 6.8UH Q75 K
L405	4012106522	FIXED COIL 10UH Q65 K-A
L406	4012106522	FIXED COIL 10UH Q65 K-A
L407	4012106522	FIXED COIL 10UH Q65 K-A
L502	4012106522	FIXED COIL 10UH Q65 K-A
L503	4012106522	FIXED COIL 10UH Q65 K-A
L101	4012224022	FIXED COIL 22UH Q40 K
L102	4012224022	FIXED COIL 22UH Q40 K
L803	4013150017	COIL CHOKE 150UH 0.82A RAD
L050	4013155022	FIXED COIL 150UH Q50 K (RAD)
L051	4013155022	FIXED COIL 150UH Q50 K (RAD)
LT401	4020150002	ADJ COIL 150NH Q50
LT301	4020251002	ADJ COIL 251NH Q50
TR602	4030001909	TRF FBT 90° (AK19)
TR802	4041804900	TRF SMPS AK19 90° (170-270V)
TR601	4050001902	LINE DRIVER NEW TYPE
TR801	4060001100	LINE FILTER 2*27MH
	4072109011	DEGAUSS COIL&EARTH CABLE (21)
L603	4090109000	LINEARITY COIL 50UH (06-06A)
SW801	4390122000	SWITCH ON/OFF PANASONIC
SW501	4390407100	SWITCH TACT SKHHLU
SW502	4390407100	SWITCH TACT SKHHLU
SW503	4390407100	SWITCH TACT SKHHLU
SW504	4390407100	SWITCH TACT SKHHLU
PL100	4930250300	CONN.ASSY.3/25 SHIELD BLUE CON
PL101	4930250301	CONN.ASSY.3/25 SHIELD GRAY CON
	4930280300	CONN.ASSY.3/28 SHIELD BLUE CON
	4930280301	CONN.ASSY.3/28 SHIELD GREY CON
	4930450400	CABLE 4/45 FC (FLAMAN) WO/SOC
	4930450401	CONN.ASSY.4/45 R26 (HRZ&VER)
	4930450502	CABLE 5/45FC (RGB AK19) WO/SOC
	4930500204	CONN.ASSY.2/50 R2.6 SPK/(R)
	4930500215	CONN.ASSY.2/50 W/BLK SPK/(L)
PL1201	4930550202	CONN.ASSY.2/55 W/SHIELD BLUE
PL101	4930550301	CONN.3/55 W/RED (HEADPHONE)
PL1202	4930550302	CONN.ASSY.3/55 W/SHIELD GREEN
	4941412415	POWER CORD ASSY.(2.4MT W/FTZ)
	5124030022	BRACKET HP XX55/65 7282/92(19)
	5127025023	SHIELD AK19 SIDE
	5127025024	SHIELD AK19 (TOP)
	5127025026	SHIELD AK19 (BOTTOM W/PVC)
	5326065097	HEATSINK 16/19-REGULATOR(2)
	5326065150	HEATSINK 19-CRT BOARD
	5326065156	HEATSINK 19-REG&AUDIO
	5326065157	HEATSINK 19-HOR&VER BACKAV 90'
	5326065159	HEATSINK 19-PRIMER 90'
F801	5357055001	FUSE HOLDER TK79-A
	5501035023	HEATSINK BRACKET
	5501035024	BRACKET HEATSINK BACK AV AK19

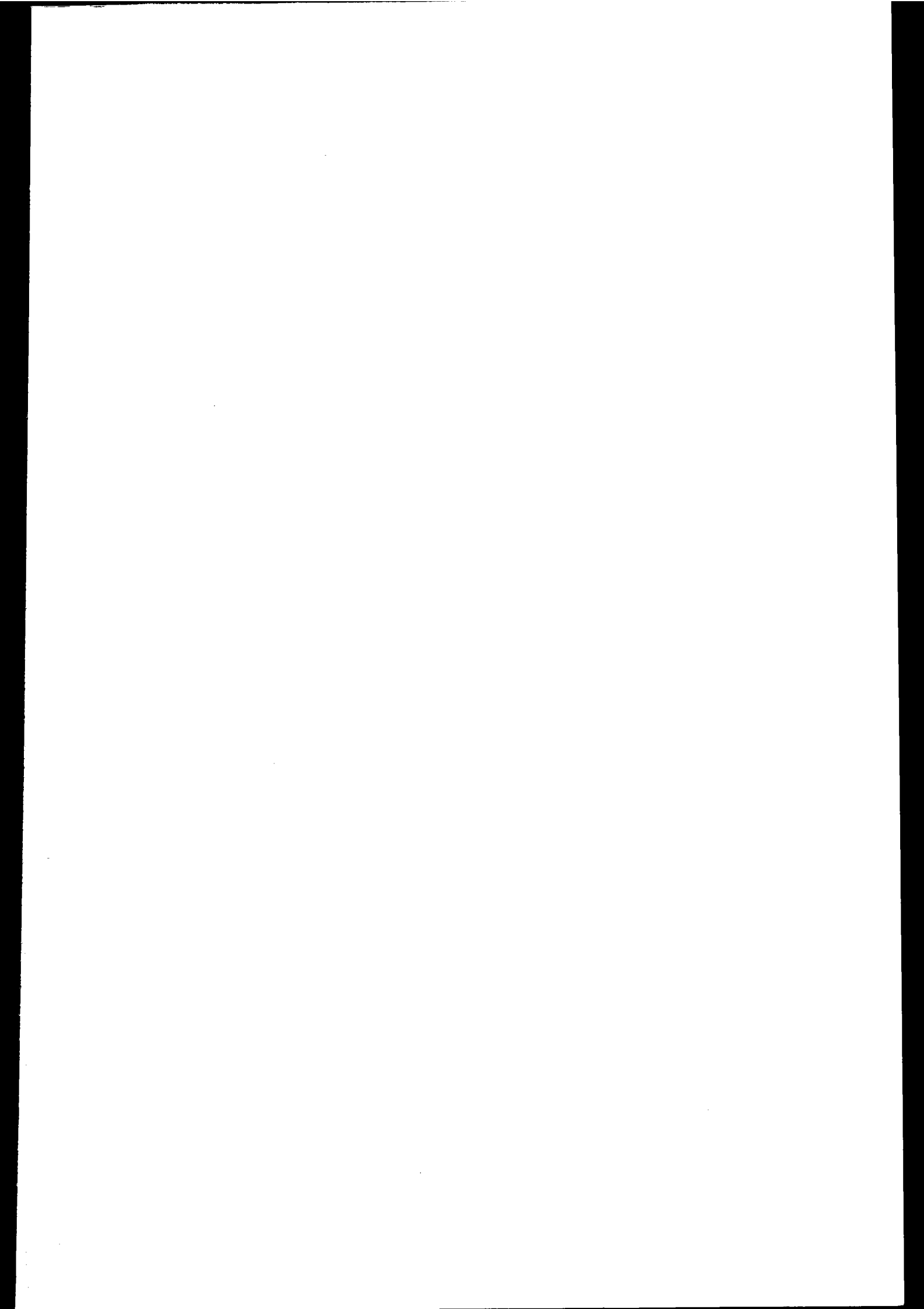

EV 51, 66, 68, 80.

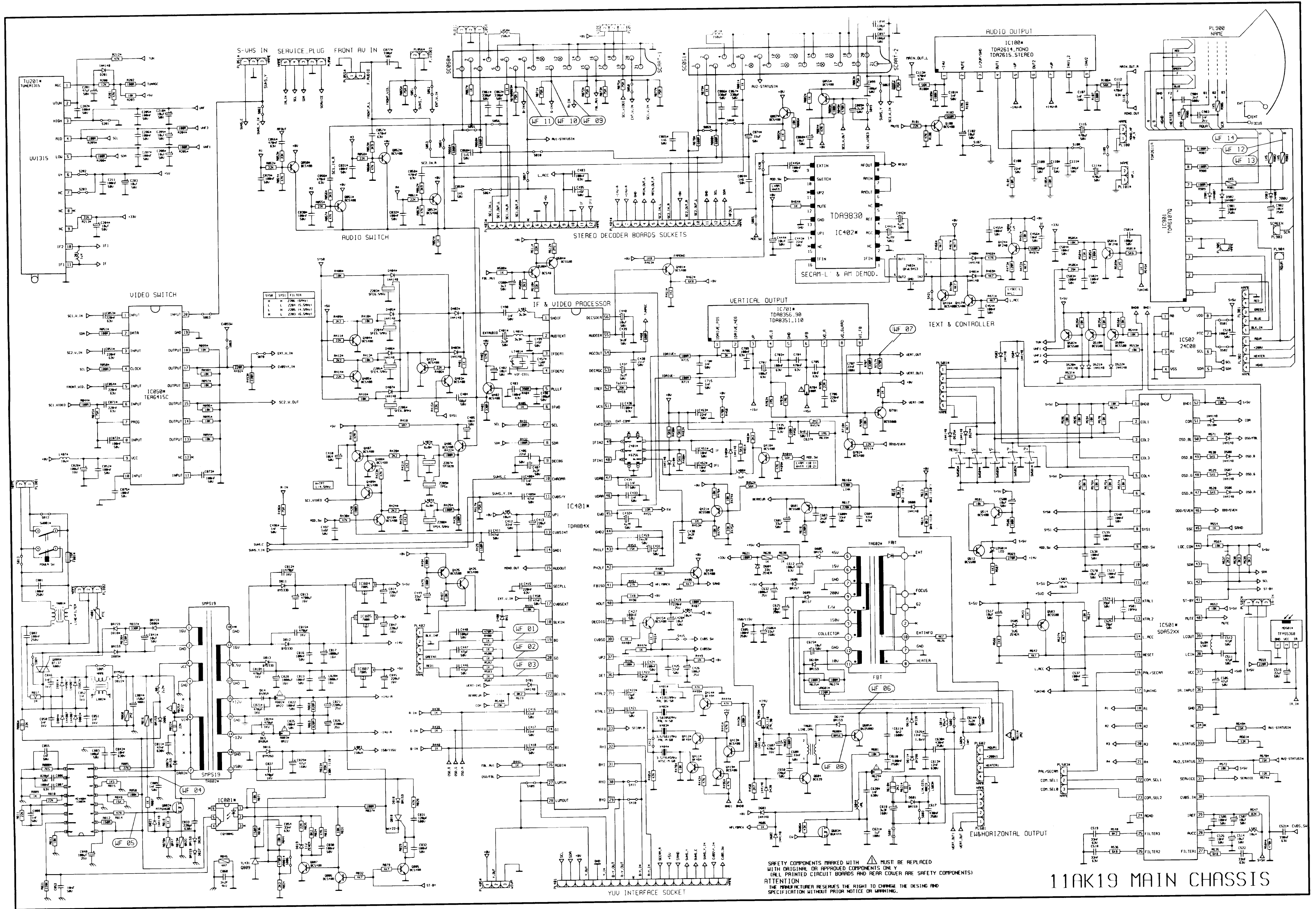
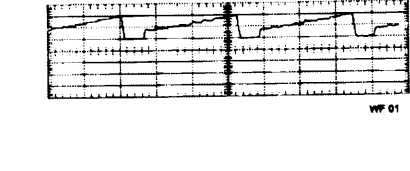
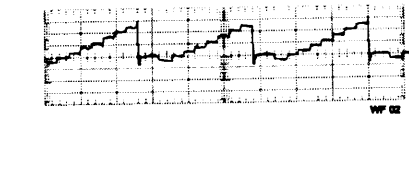
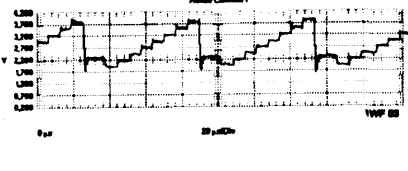
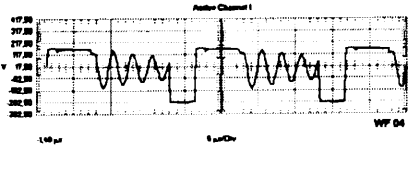
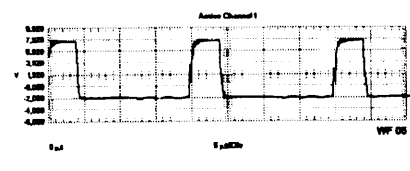
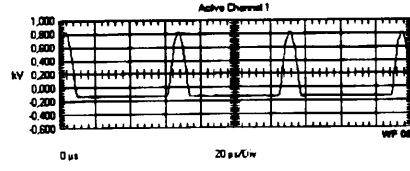
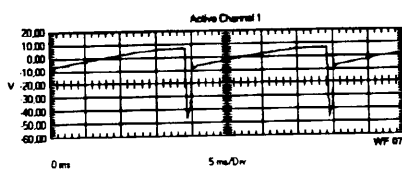

11AK19 MAIN CHASSIS

